

6 mm PLY



THE WESTERN SKIFF designed by Nigel Irens and Ed Burnett
brought to you by Practical Boat Owner Magazine

These plans are free for personal use only. Please make a donation to: www.justgiving.com/remember/201501/Ed-Burnett

For commercial use (ie building boats for resale) contact www.nigelirens.com

Plywood kits of the boat are available from www.jordanboats.co.uk

Updated copies of the building templates, instructions and sail plan are available from www.pbo.co.uk

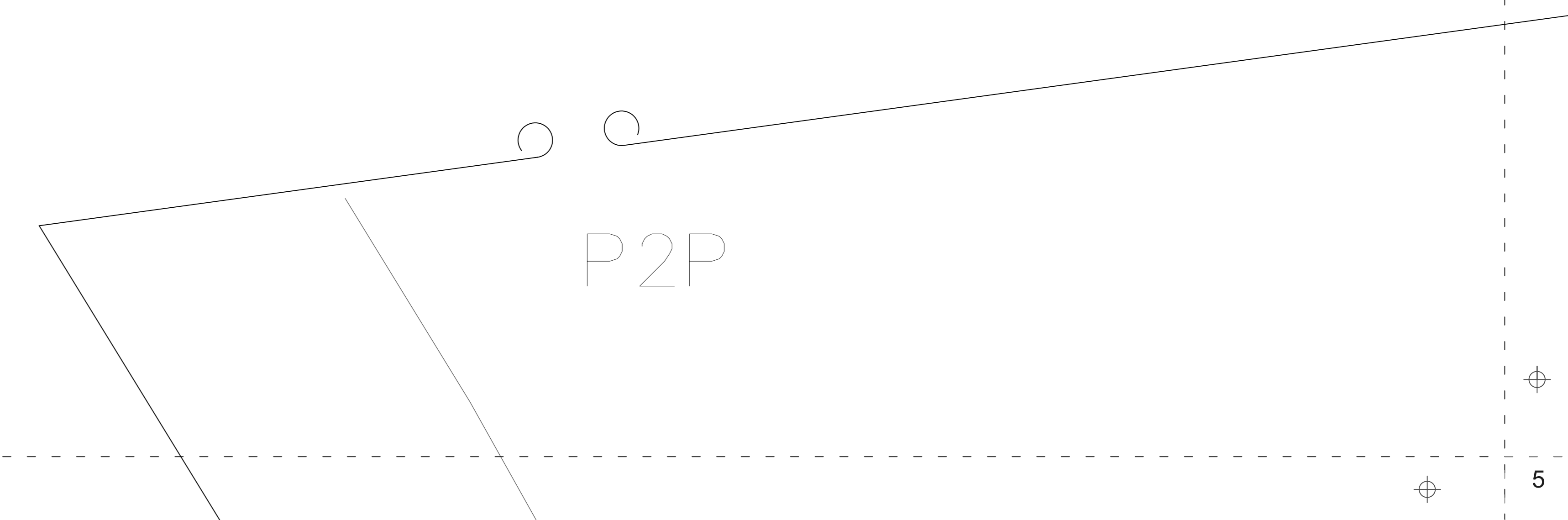
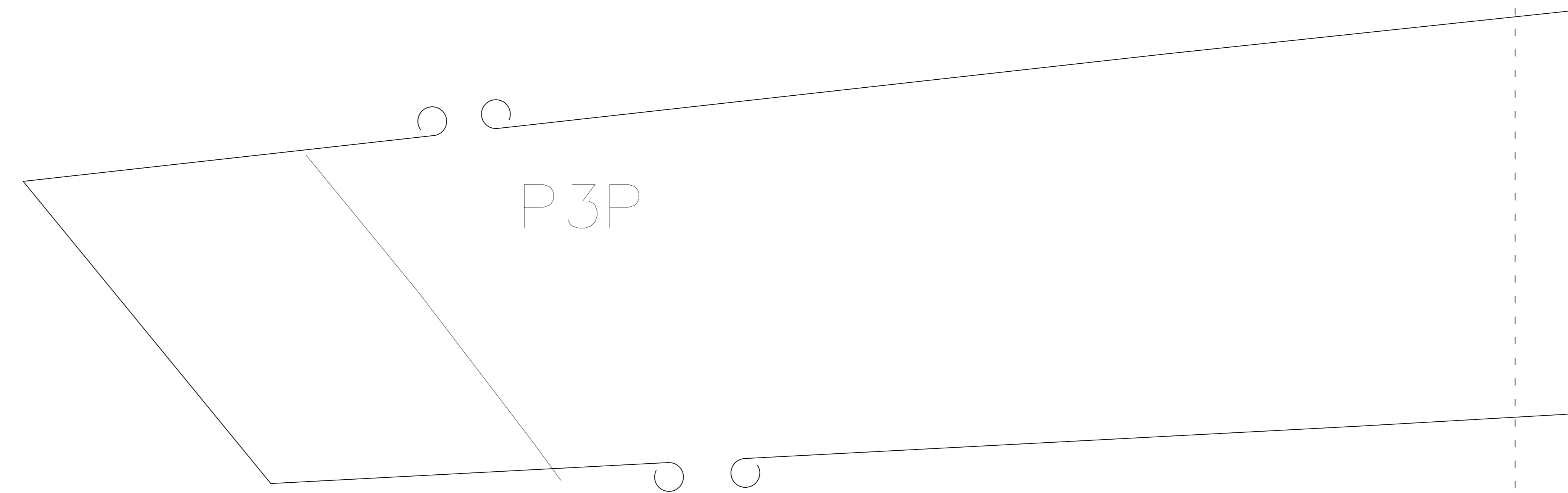



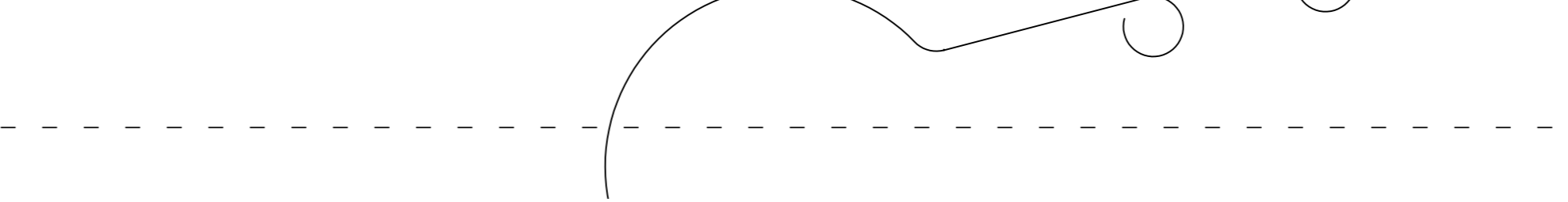
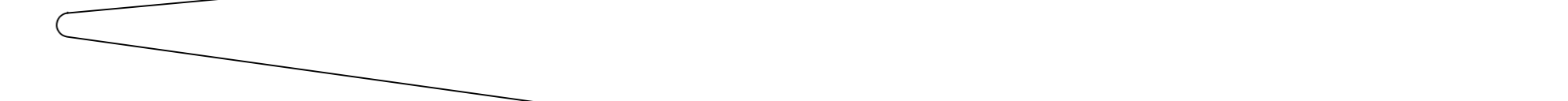
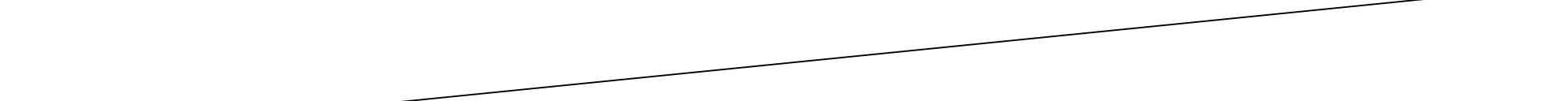
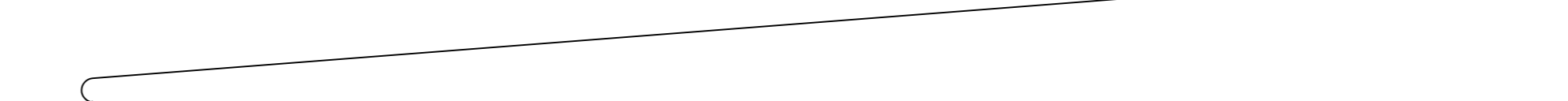
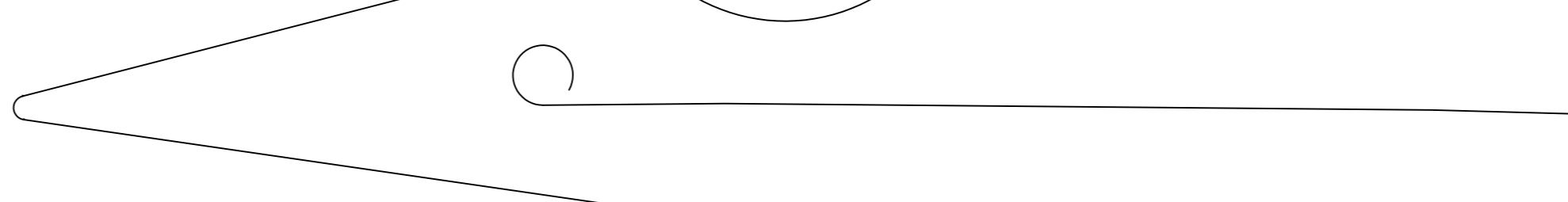
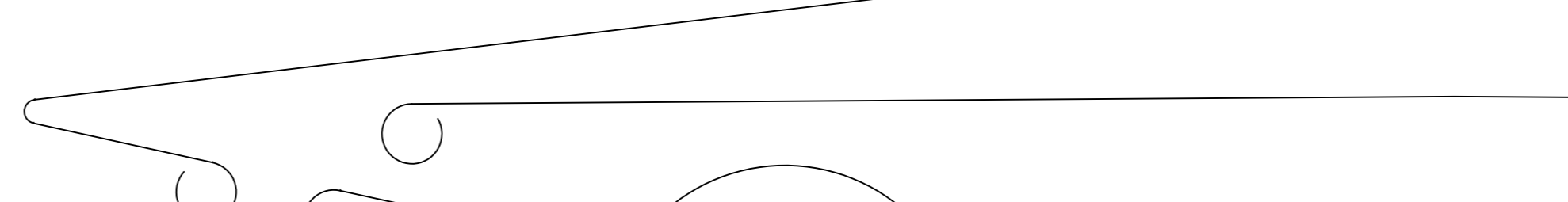
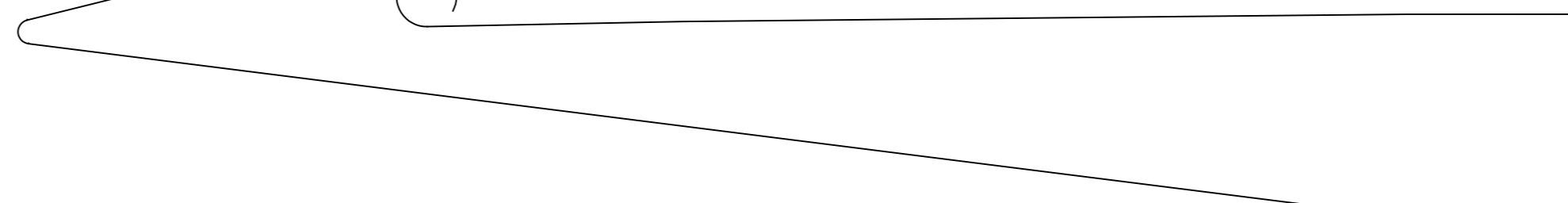
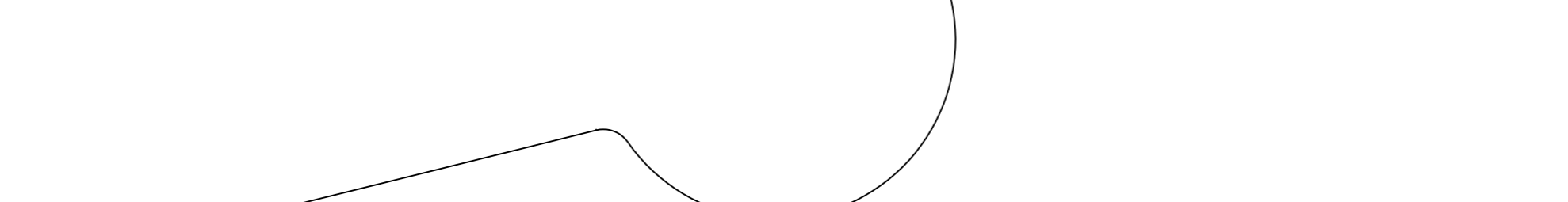
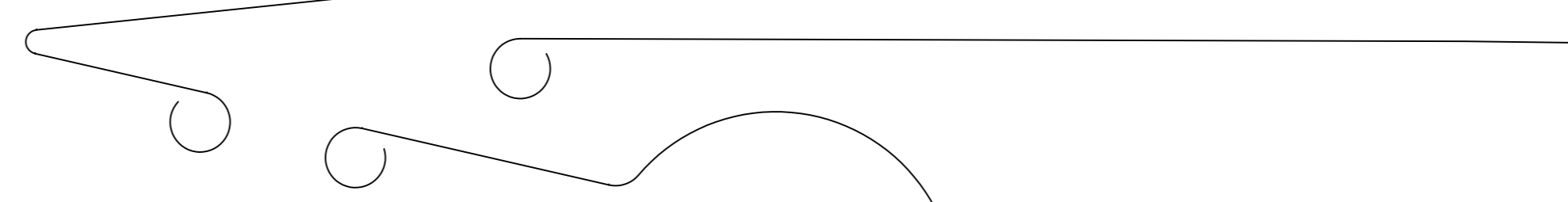
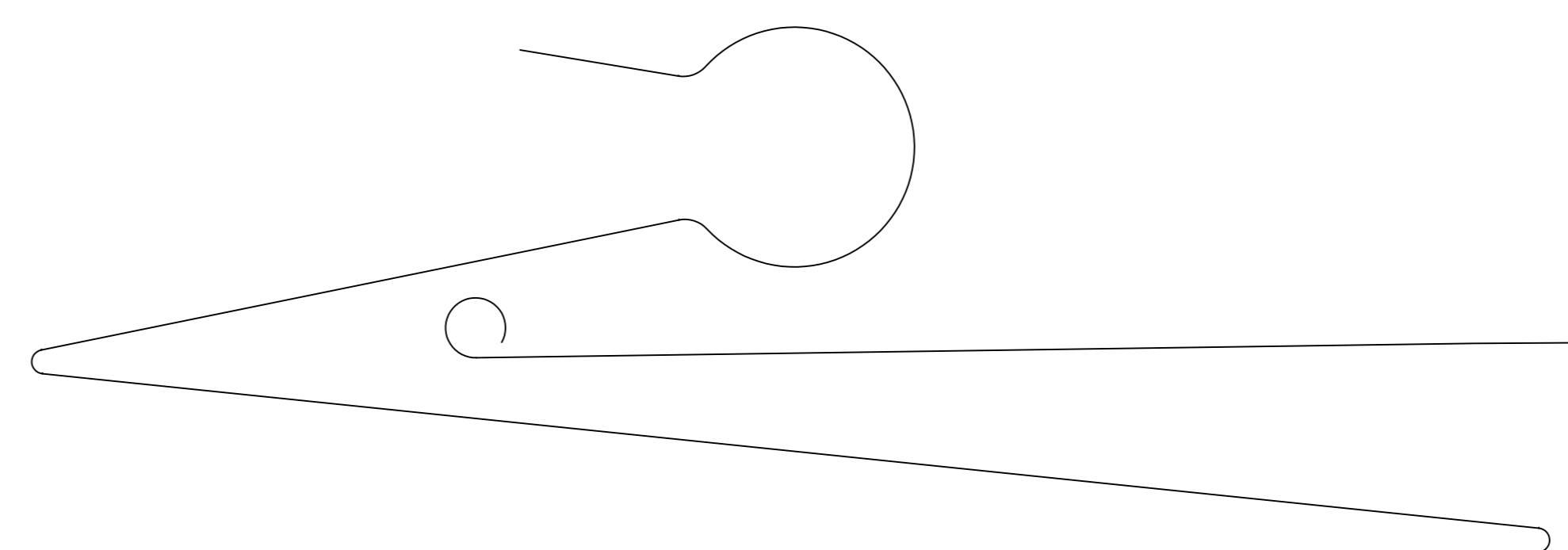
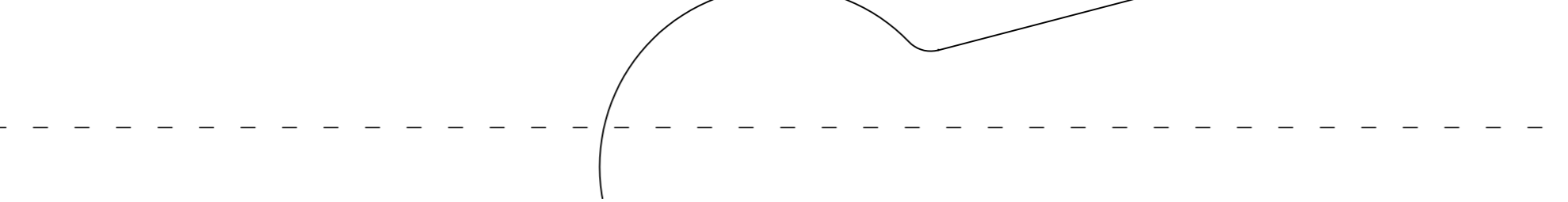
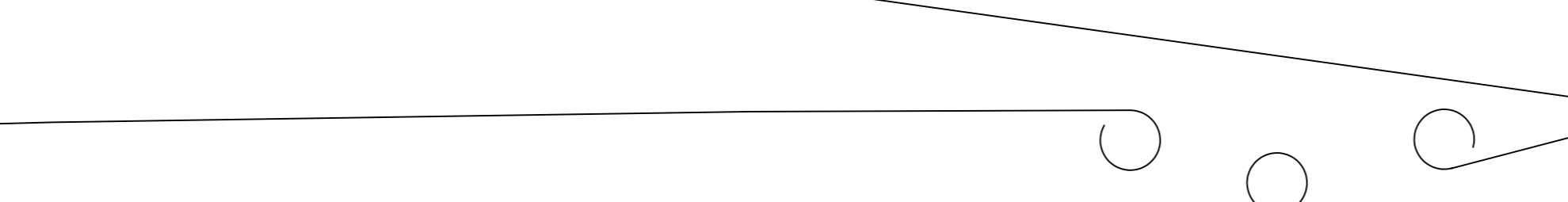
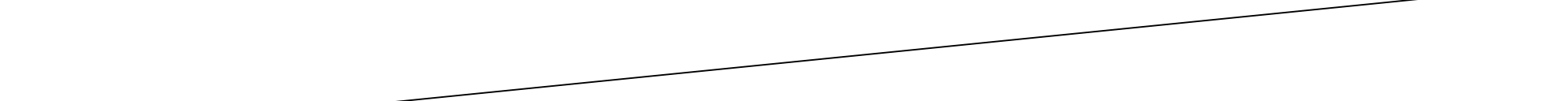
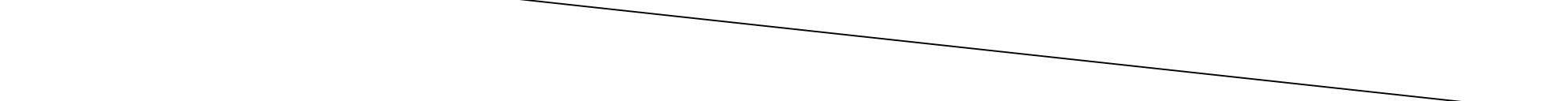
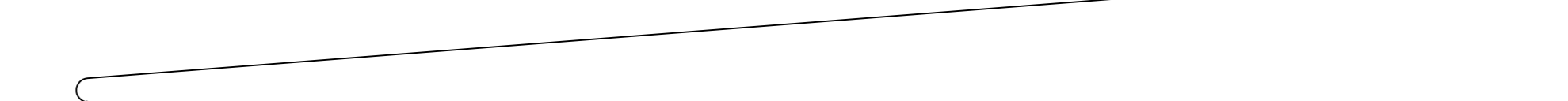
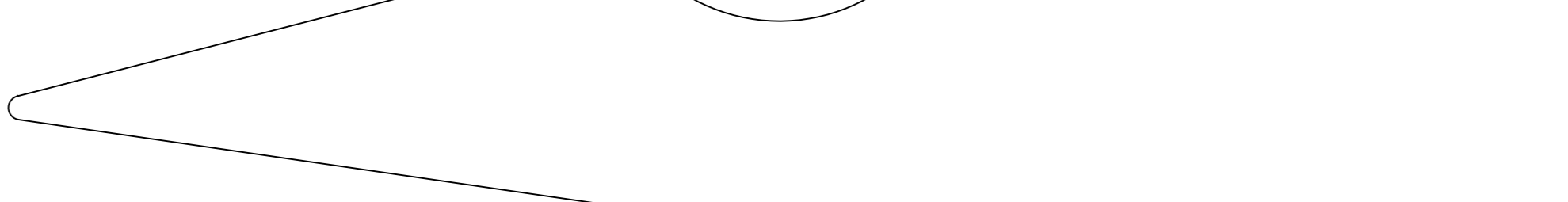
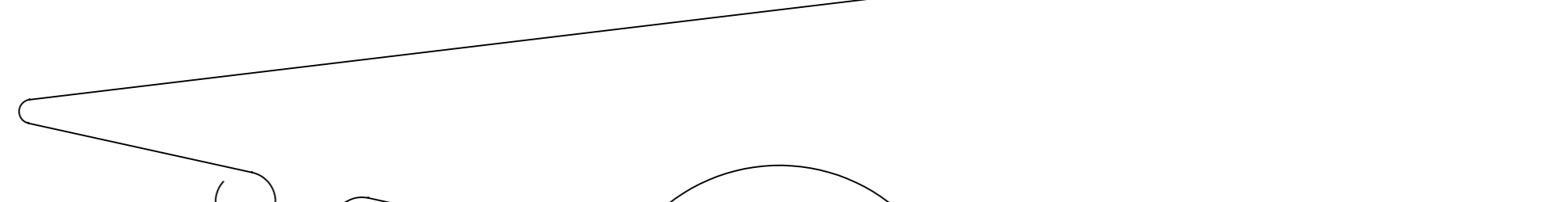
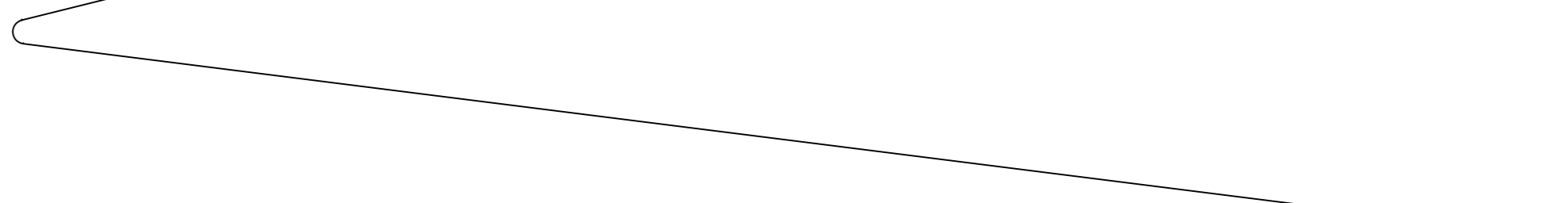
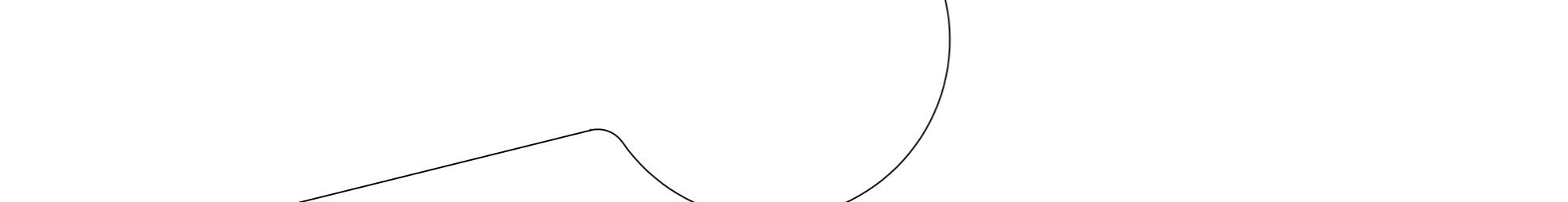
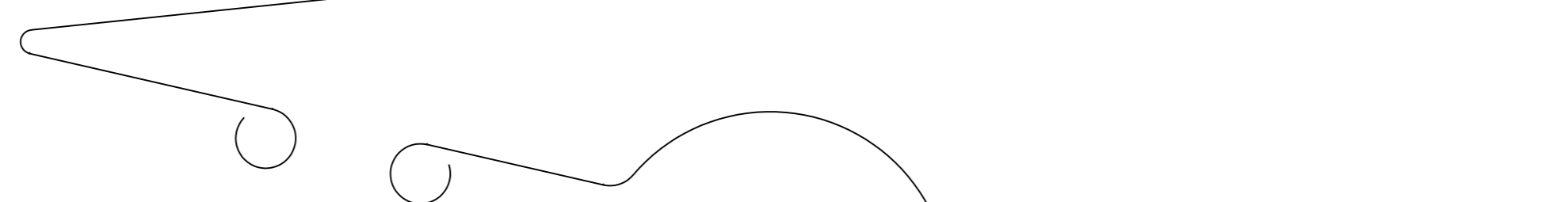
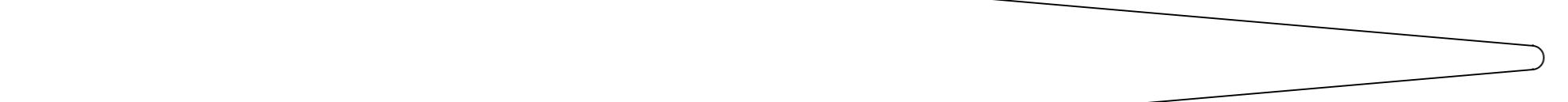
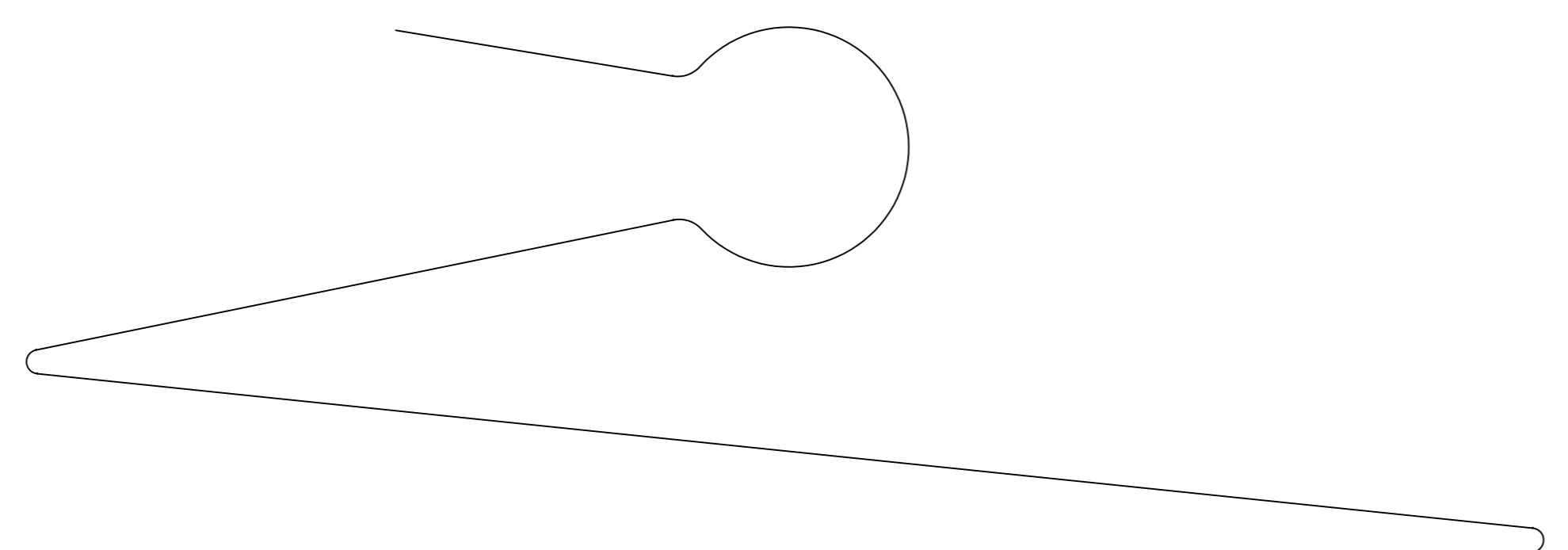
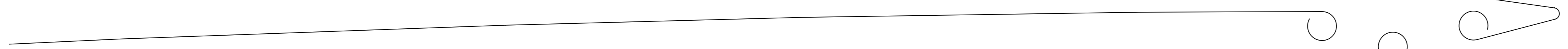
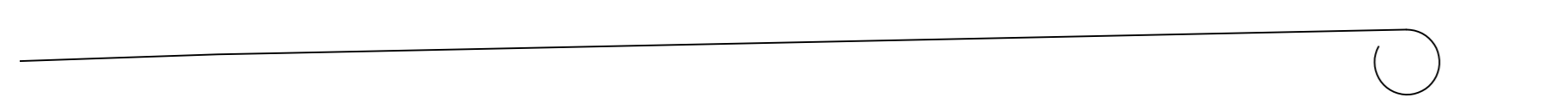
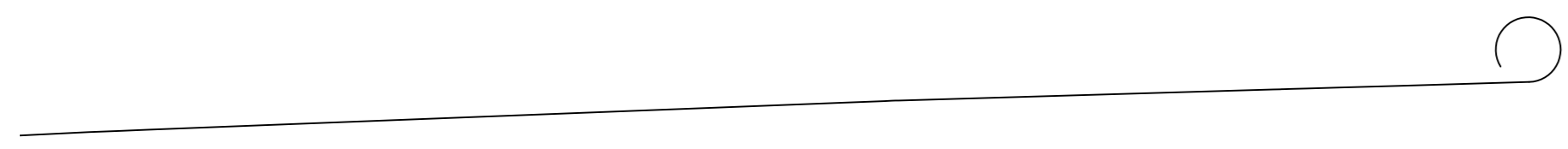
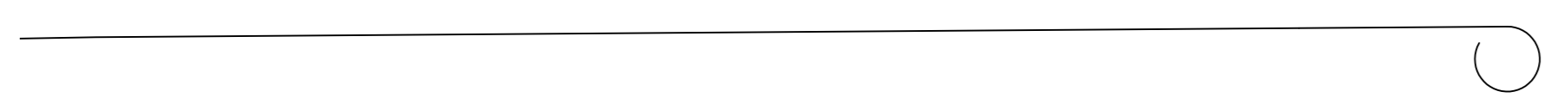



6 mm PLY

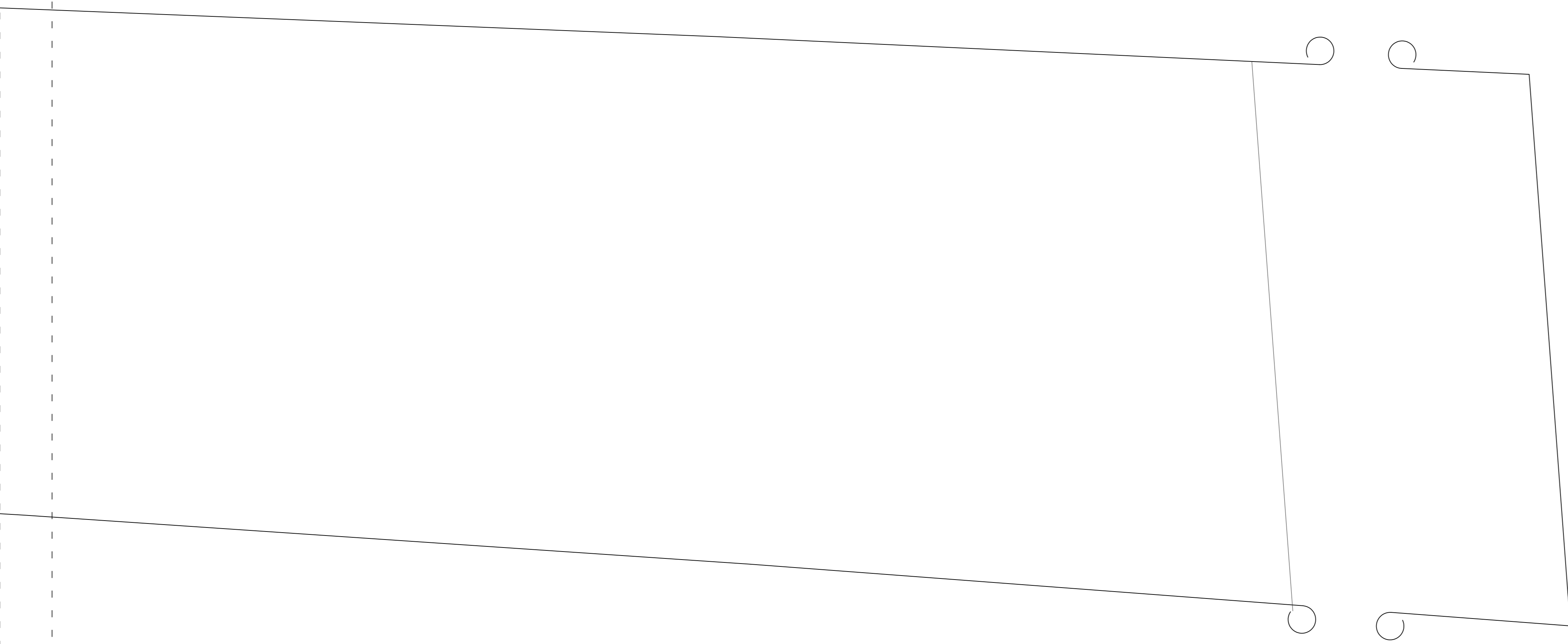

THE WESTERN SKIFF designed by Nigel Irens and Ed Burnett
brought to you by Practical Boat Owner Magazine

These plans are free for personal use only. Please make a donation to: www.justgiving.com/remember/201501/Ed-Burnett

For commercial use (ie building boats for resale) contact www.nigelirens.com

Plywood kits of the boat are available from www.jordanboats.co.uk

Updated copies of the building templates, instructions and sail plan are available from www.pbo.co.uk

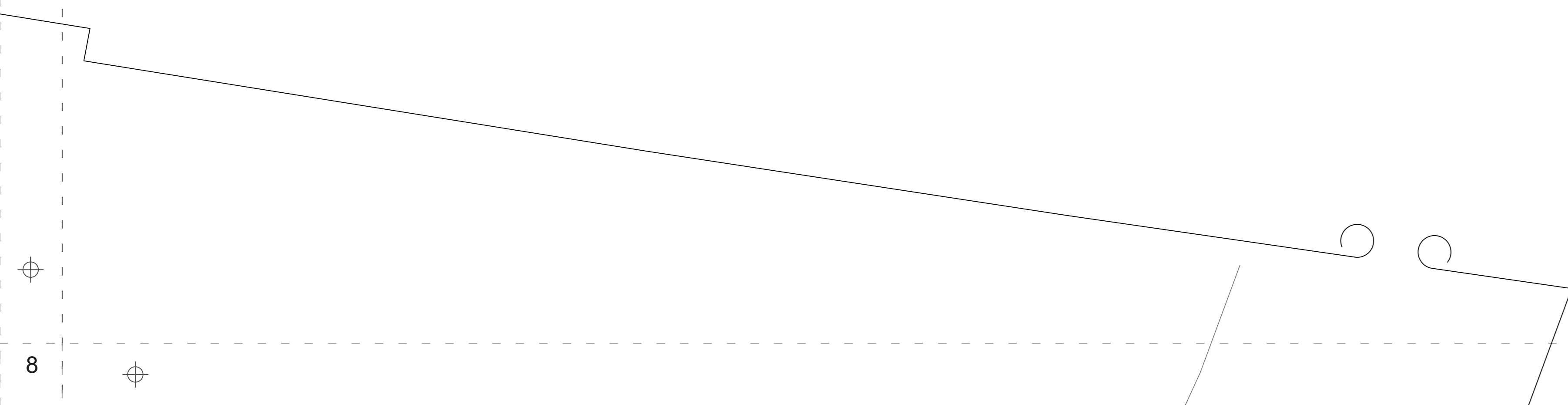

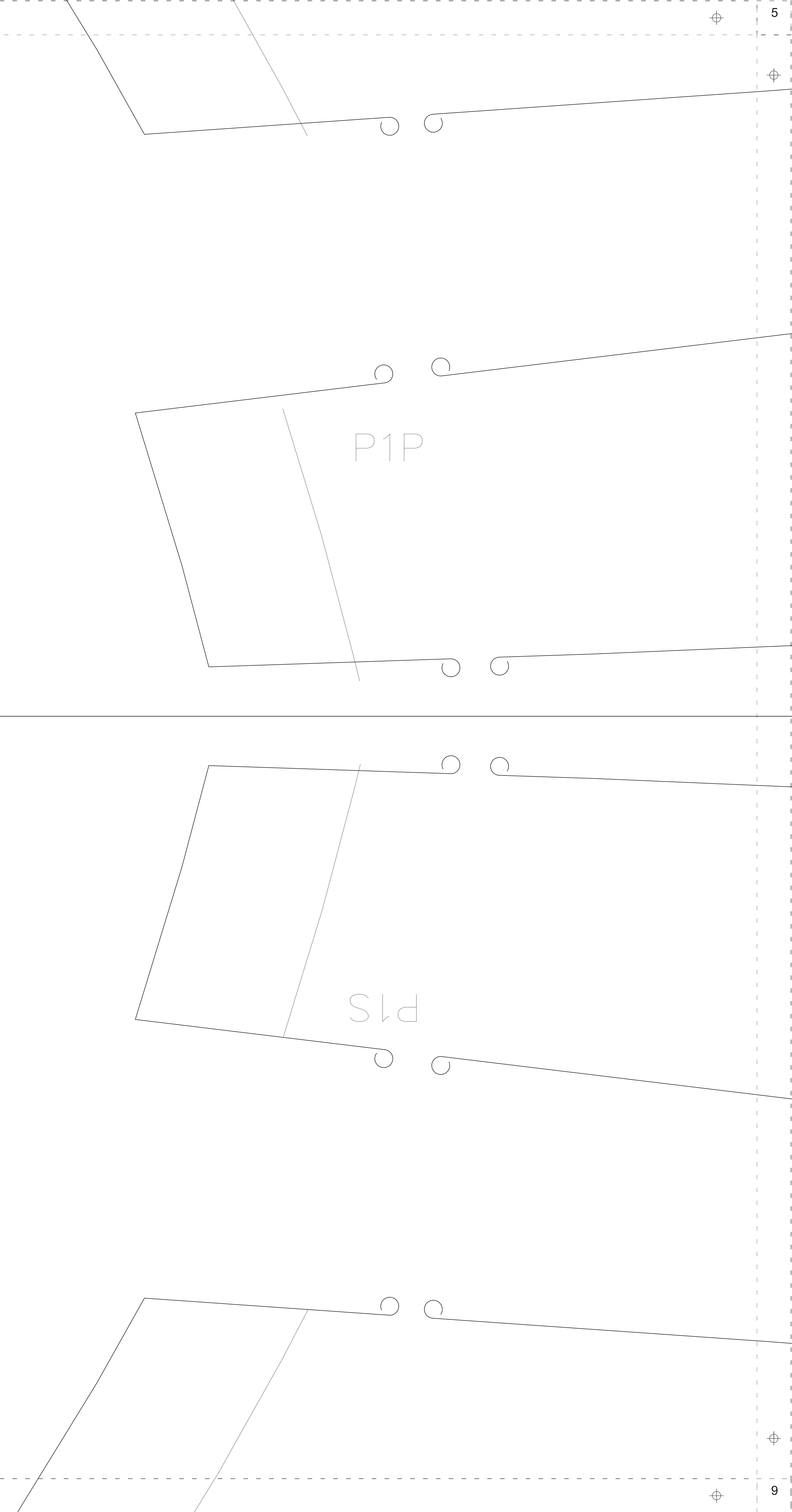

6 mm PLY



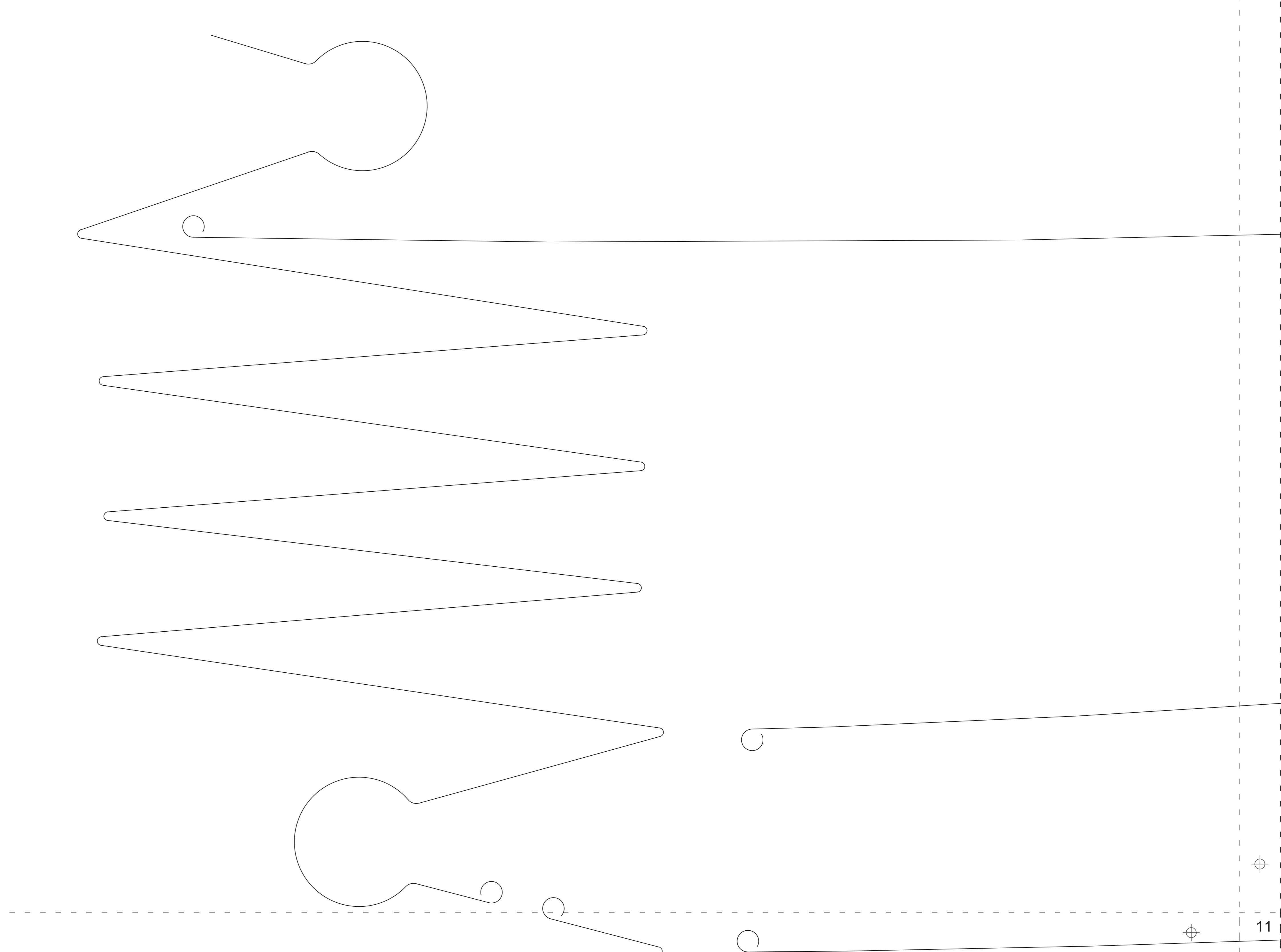
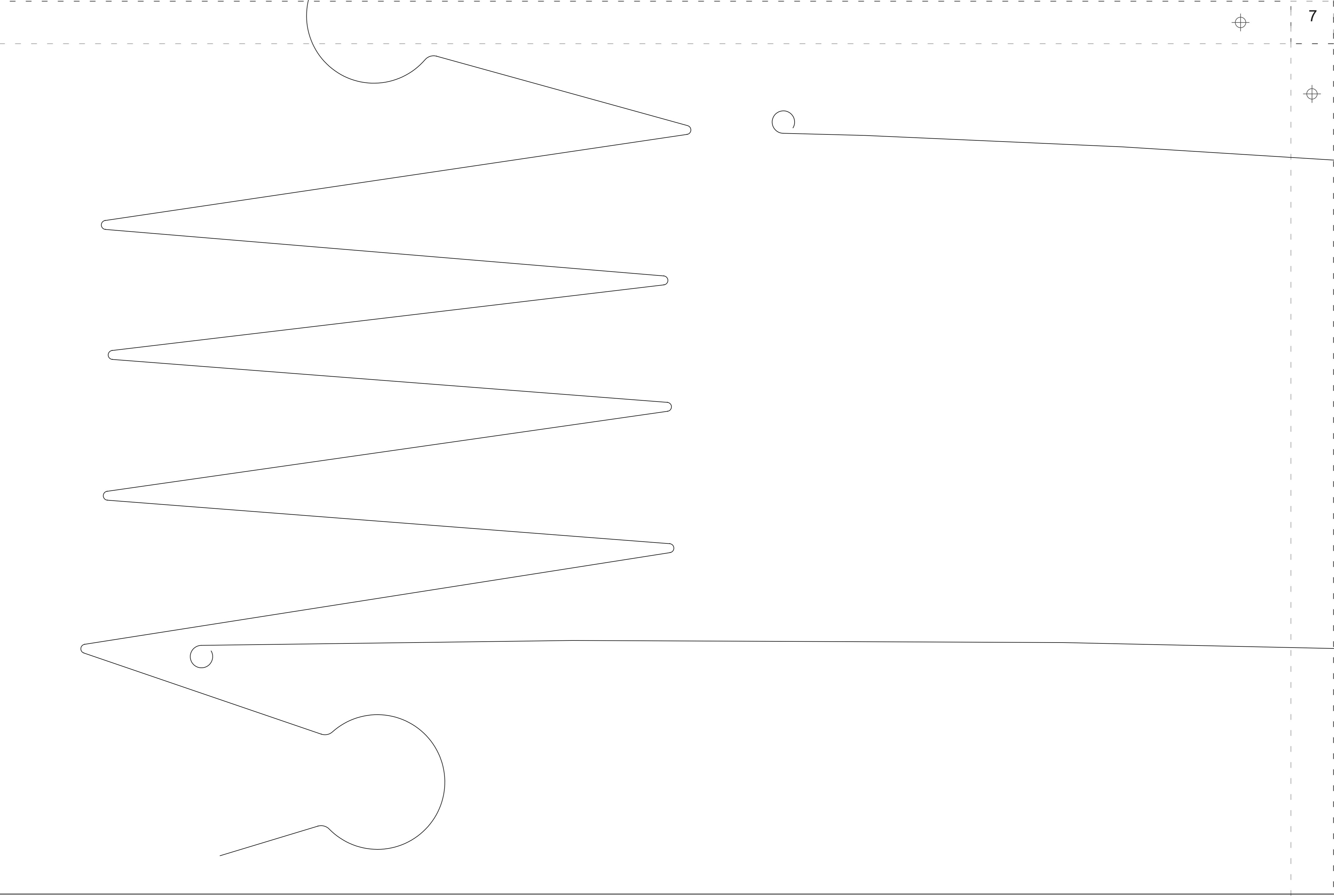
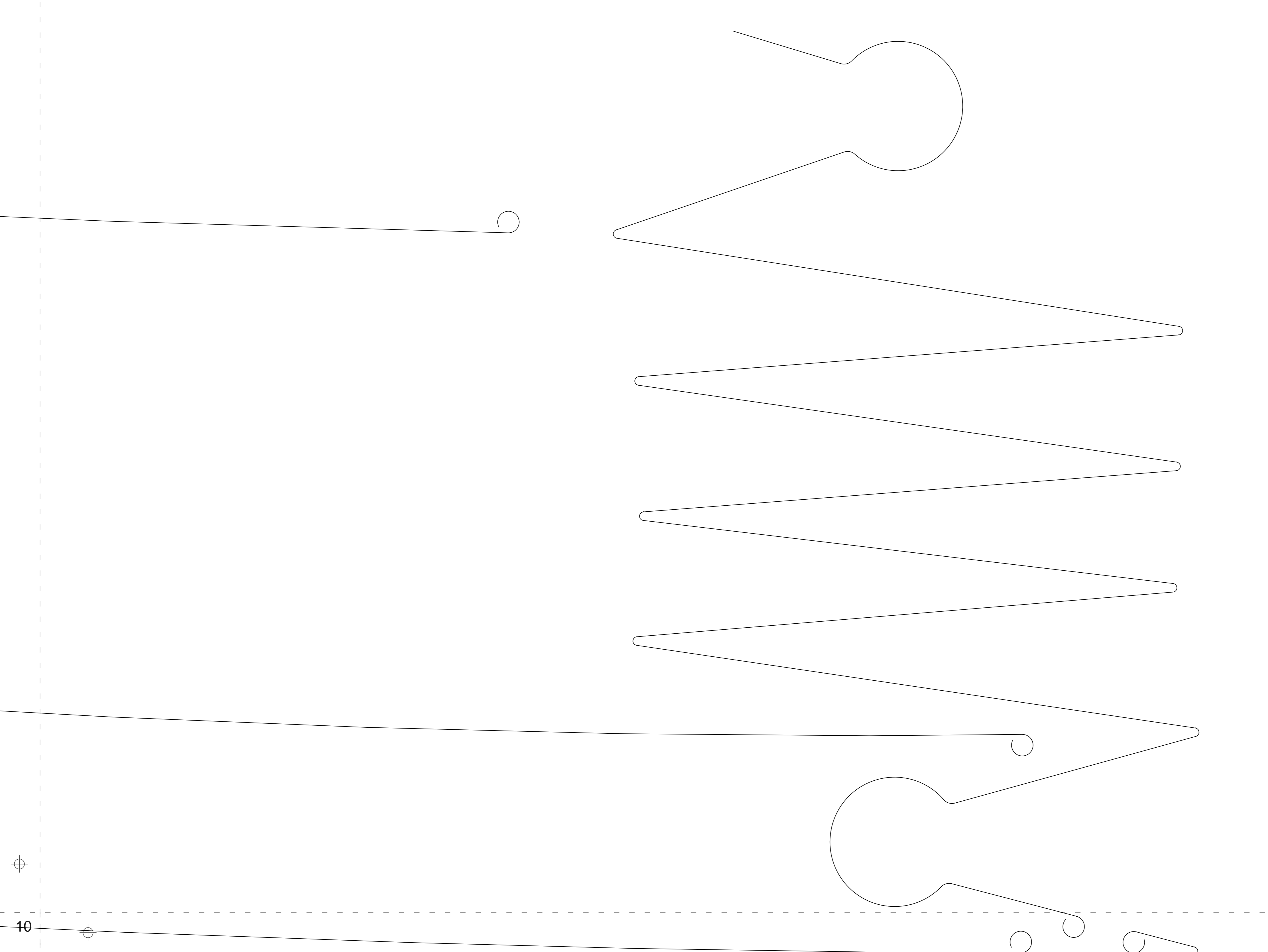
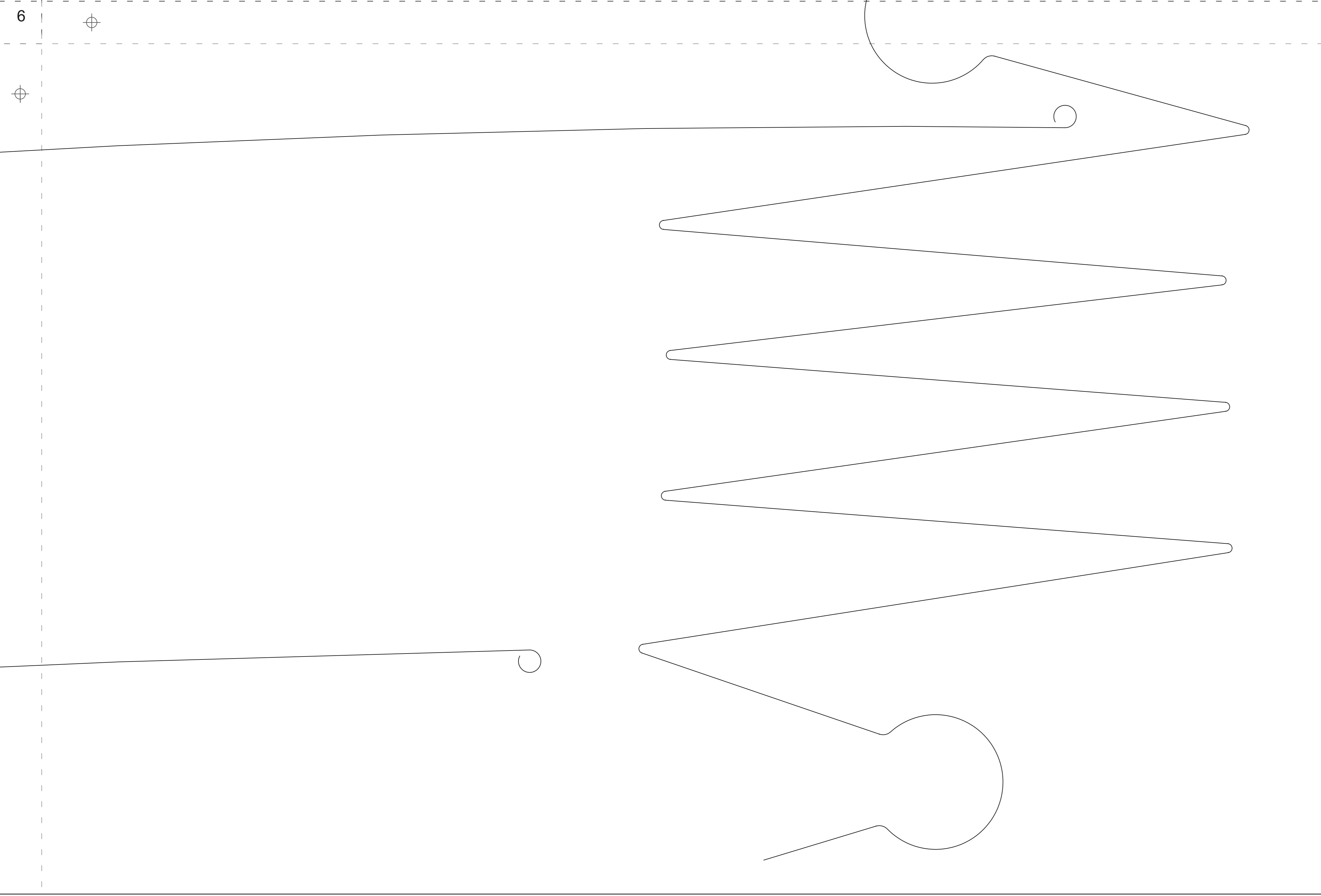

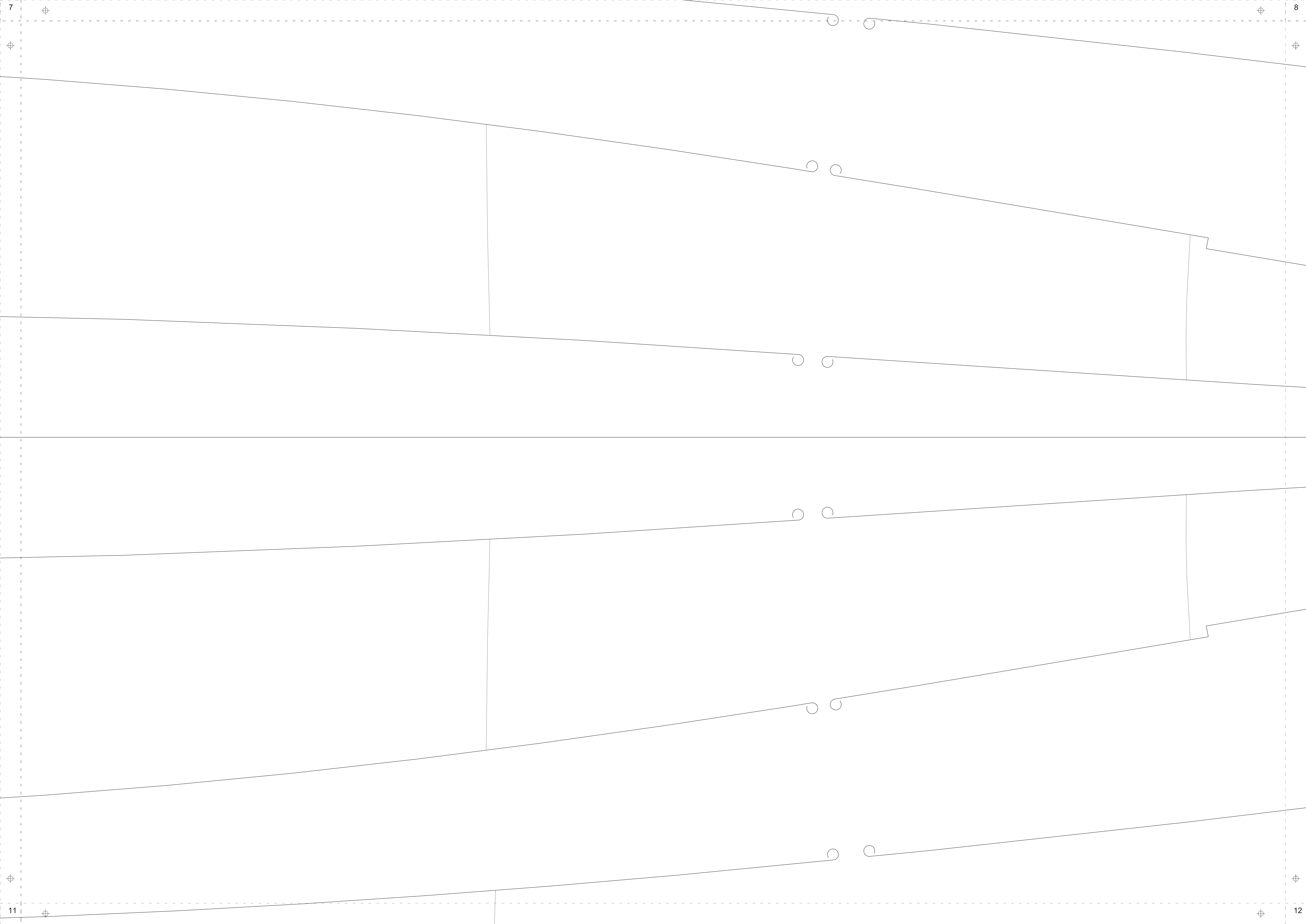

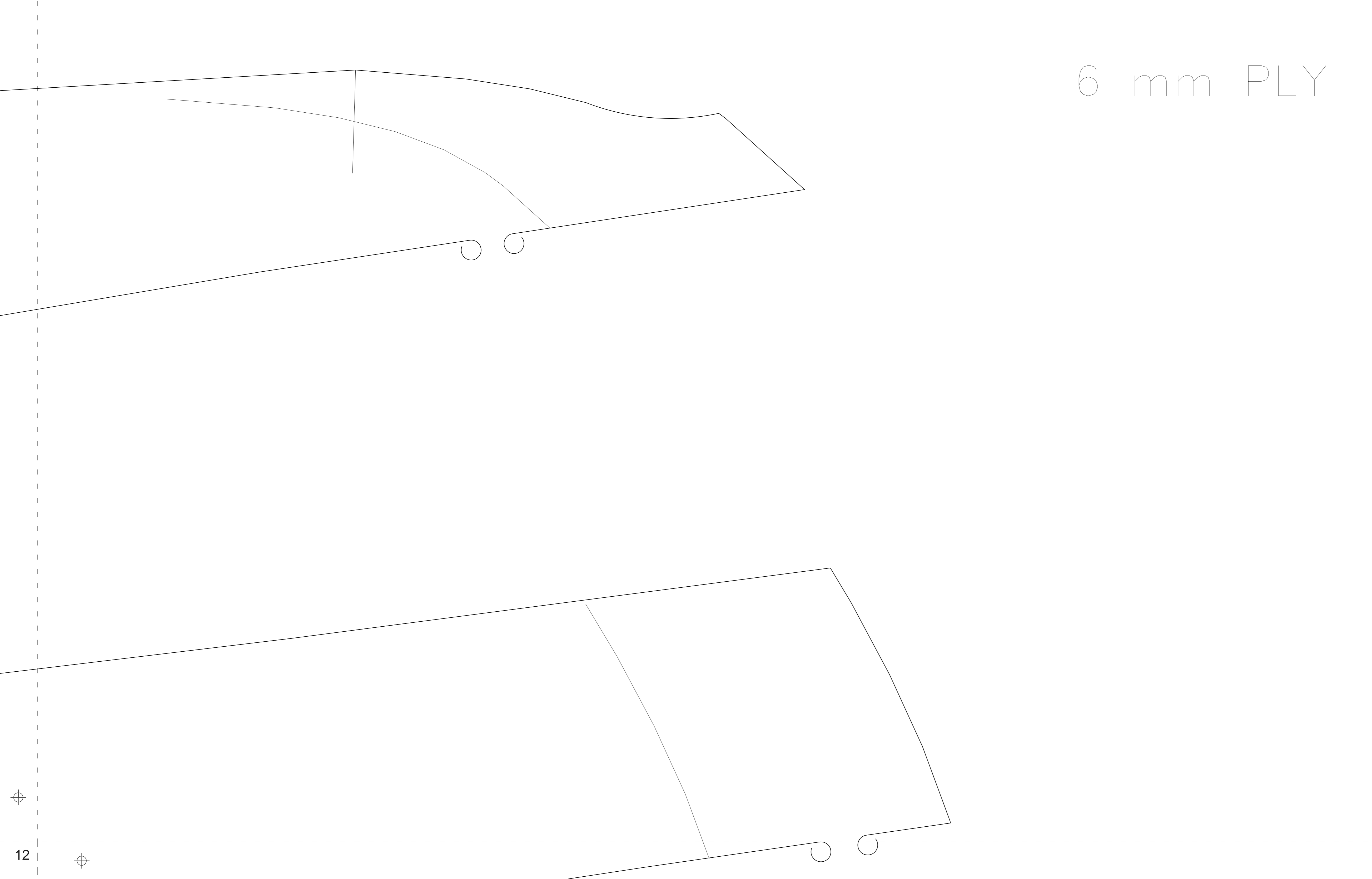
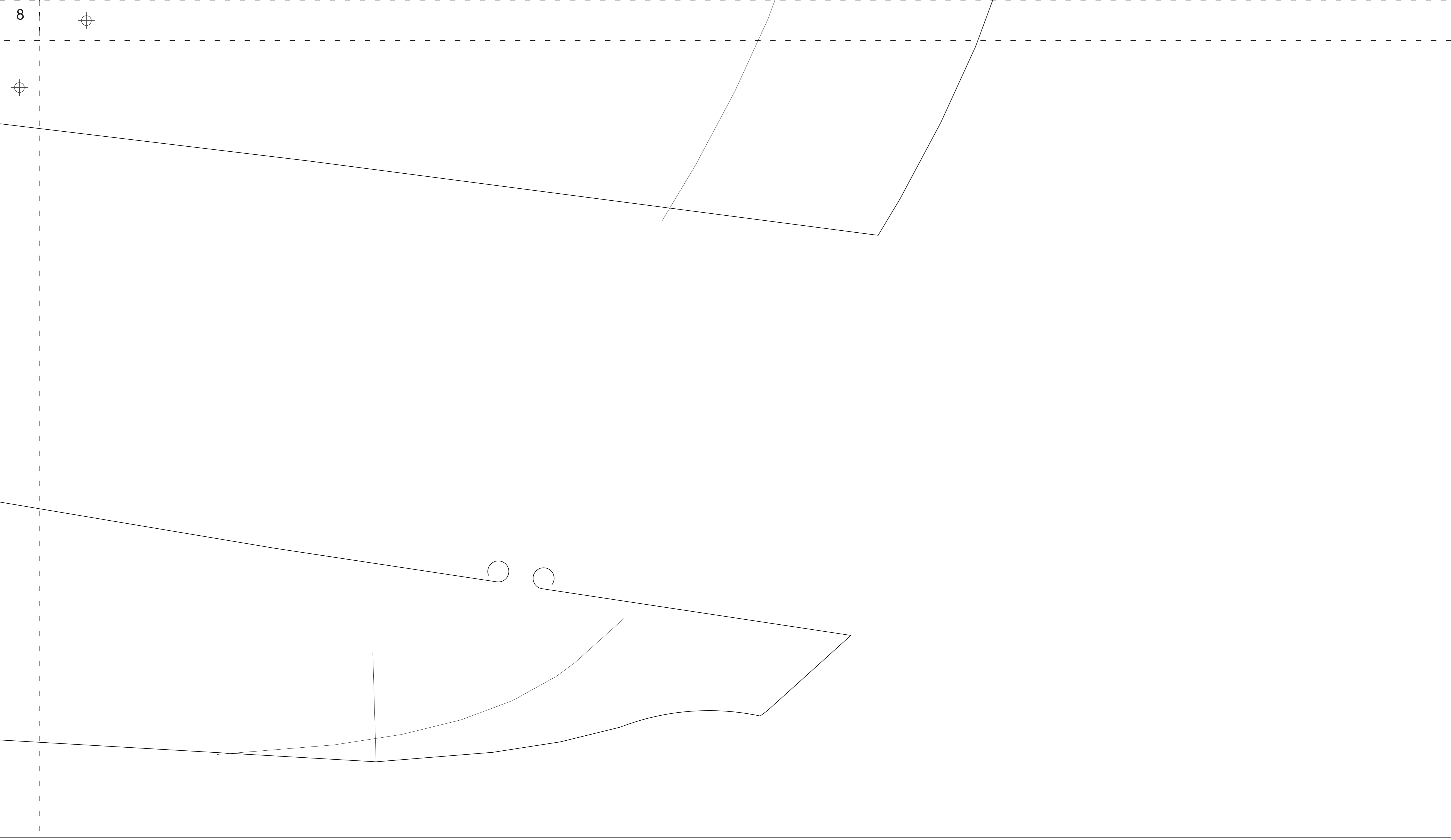

6 mm PLY

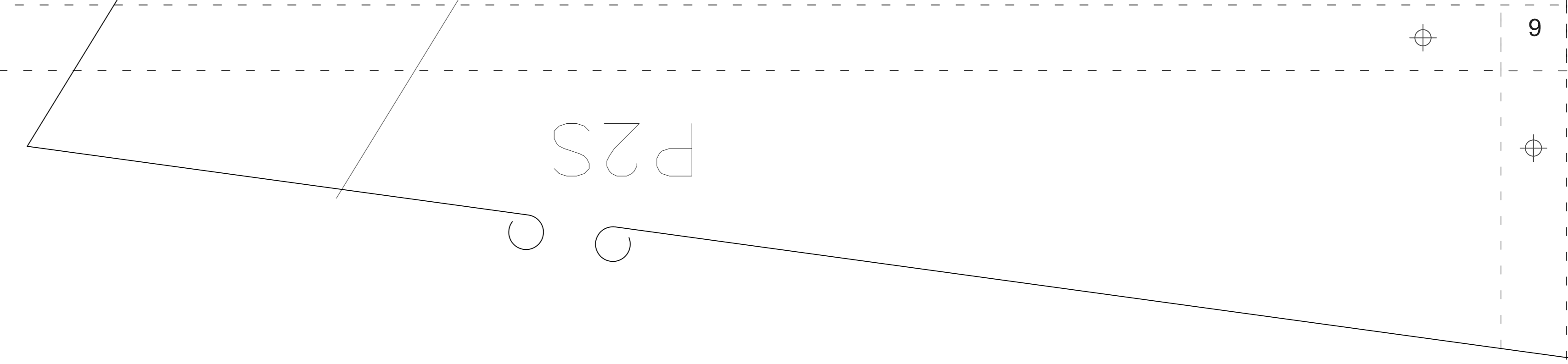

THE WESTERN SKIFF designed by Nigel Irens and Ed Burnett
brought to you by Practical Boat Owner Magazine
These plans are free for personal use only. Please make a donation to: www.justgiving.com/remember/201501/Ed-Burnett
For commercial use (ie building boats for resale) contact www.nigelirens.com
Plywood kits of the boat are available from www.jordanboats.co.uk
Updated copies of the building templates, instructions and sail plan are available from www.pbo.co.uk

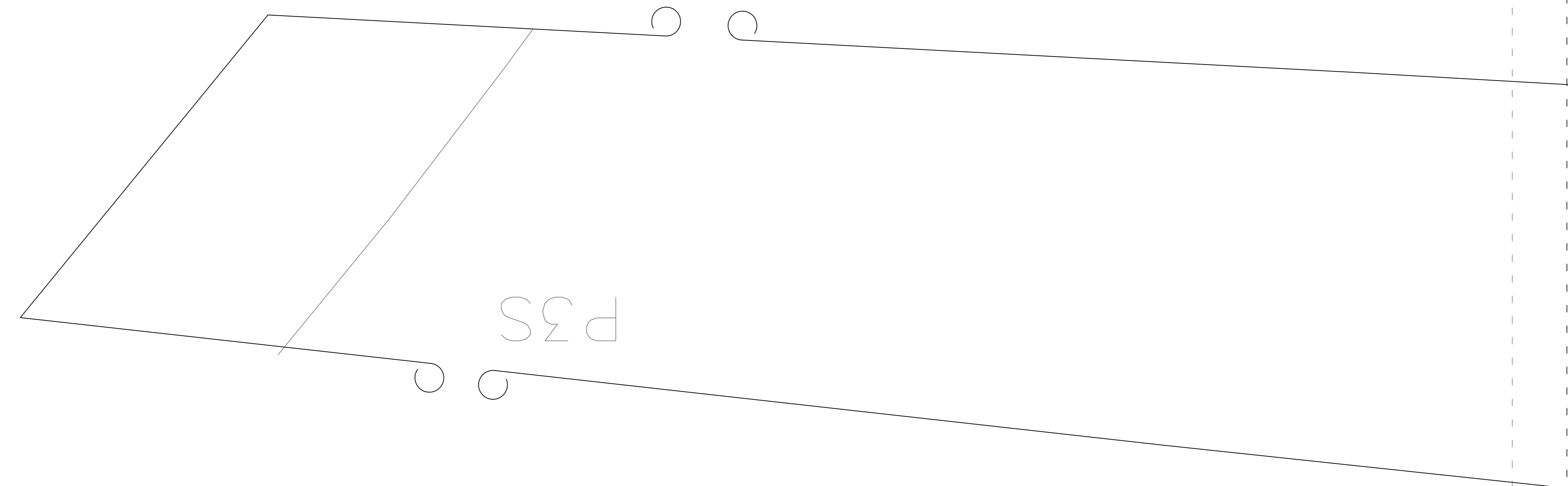

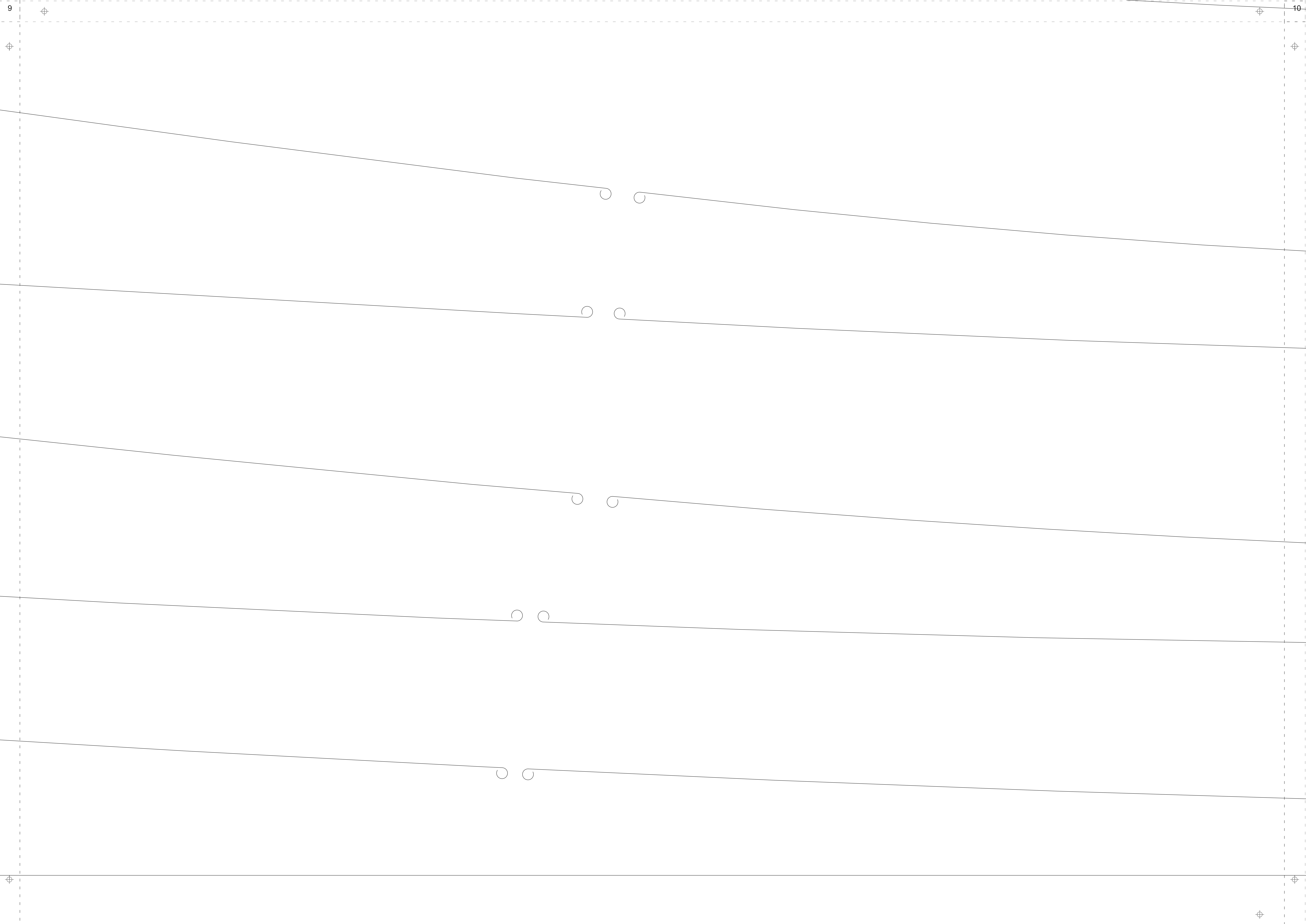

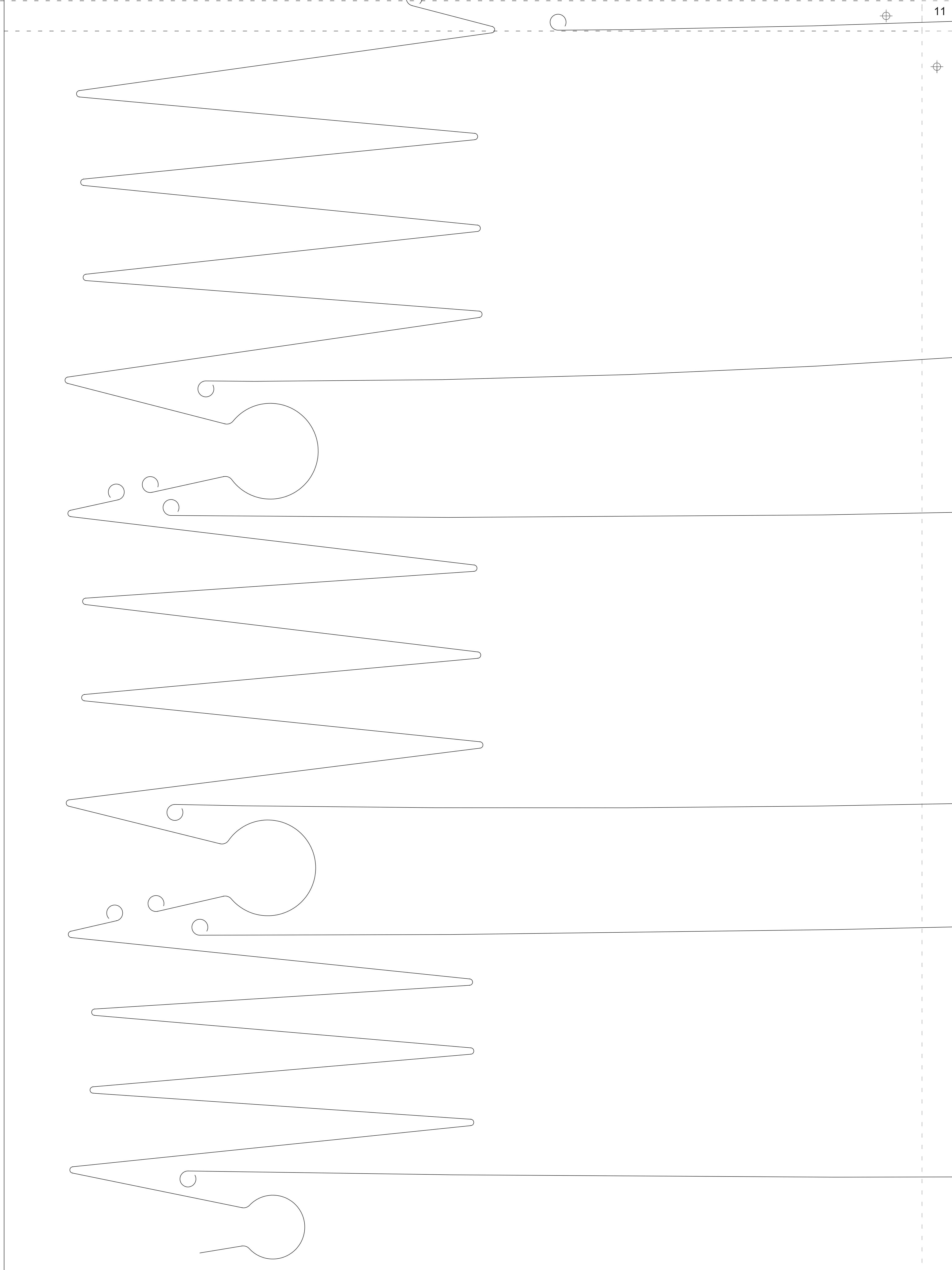
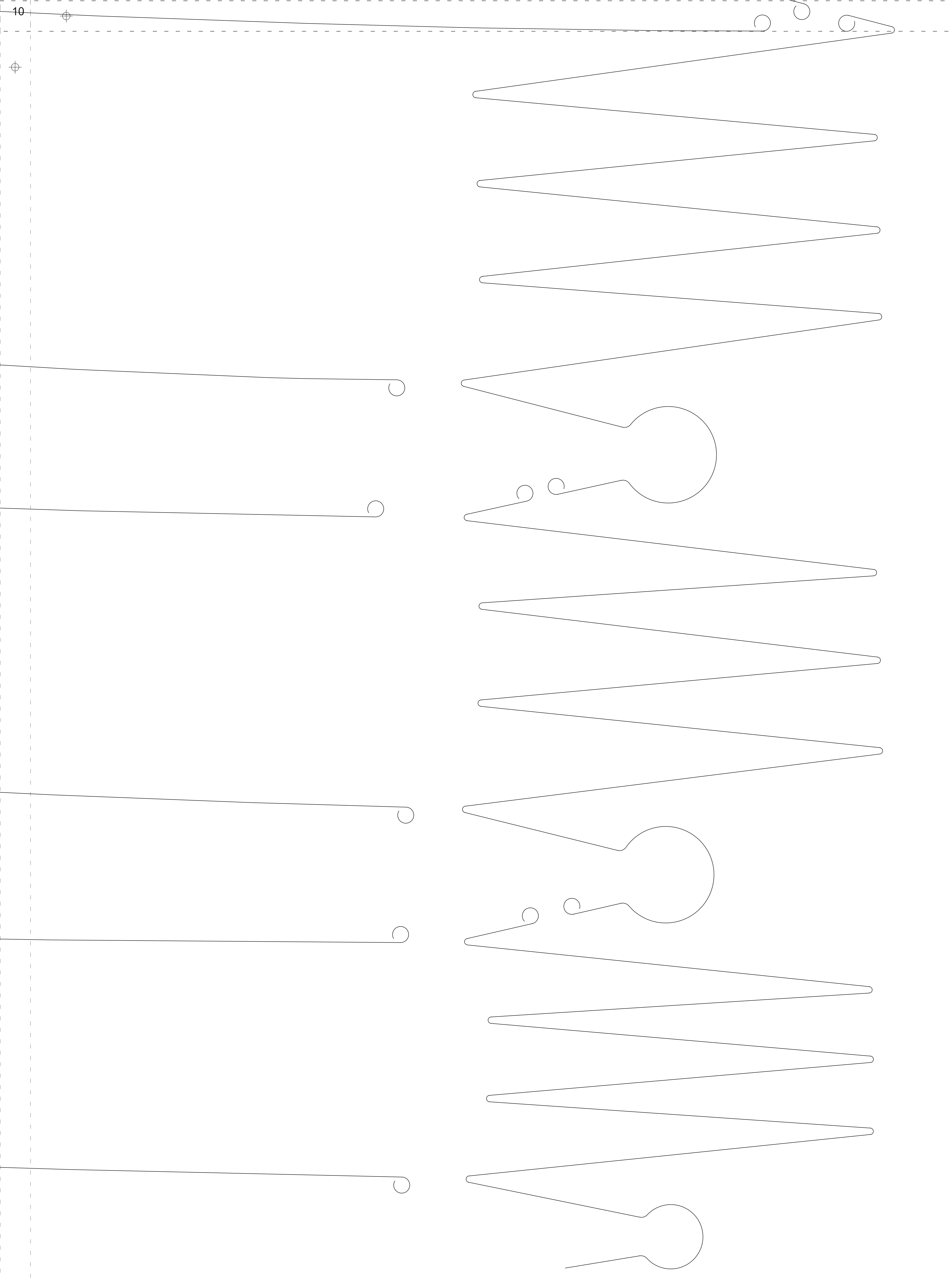

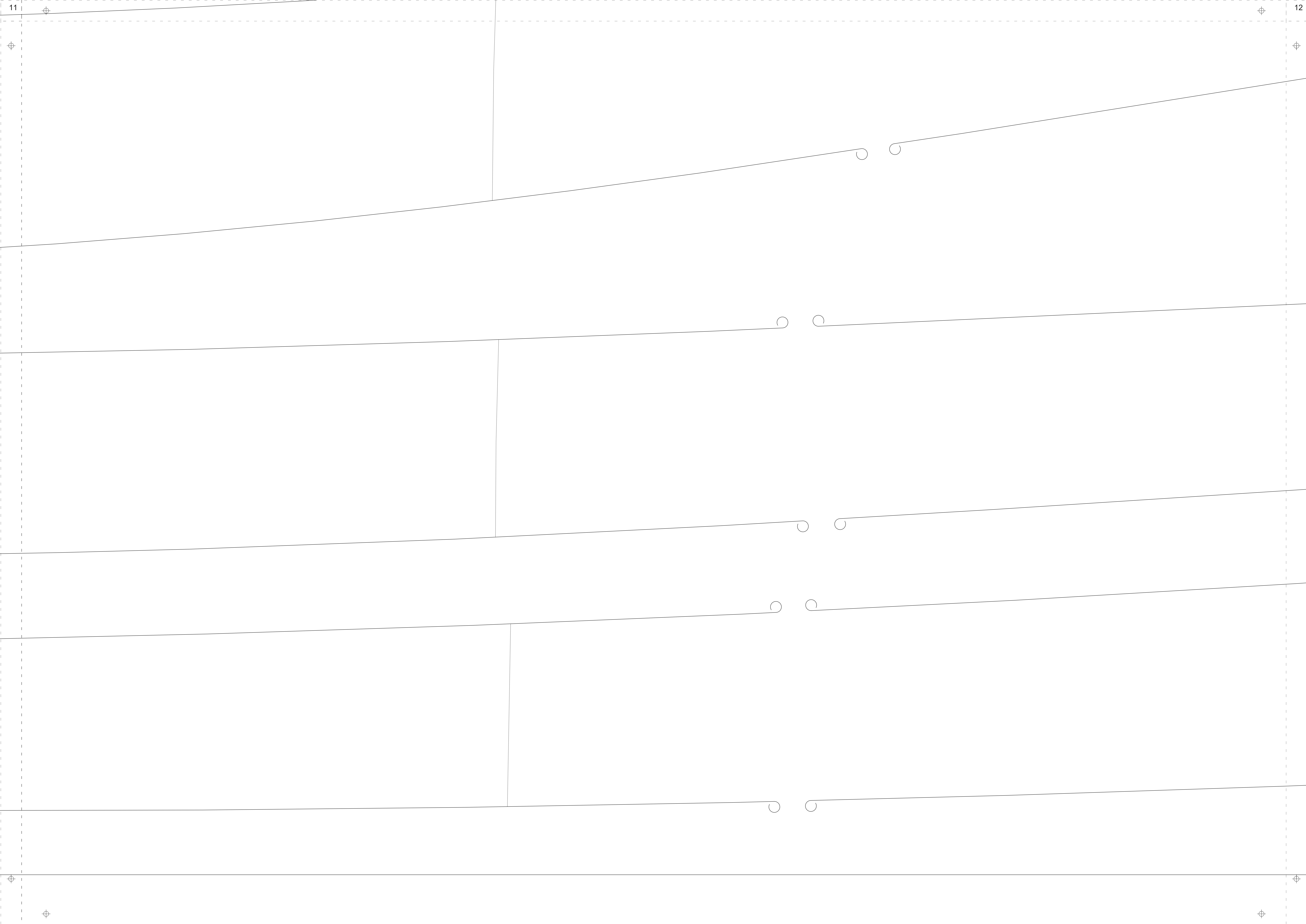

THE WESTERN SKIFF designed by Nigel Irens and Ed Burnett
brought to you by Practical Boat Owner Magazine

These plans are free for personal use only. Please make a donation to: www.justgiving.com/remember/201501/Ed-Burnett

For commercial use (ie building boats for resale) contact www.nigelirens.com

Plywood kits of the boat are available from www.jordanboats.co.uk

Updated copies of the building templates, instructions and sail plan are available from www.pbo.co.uk



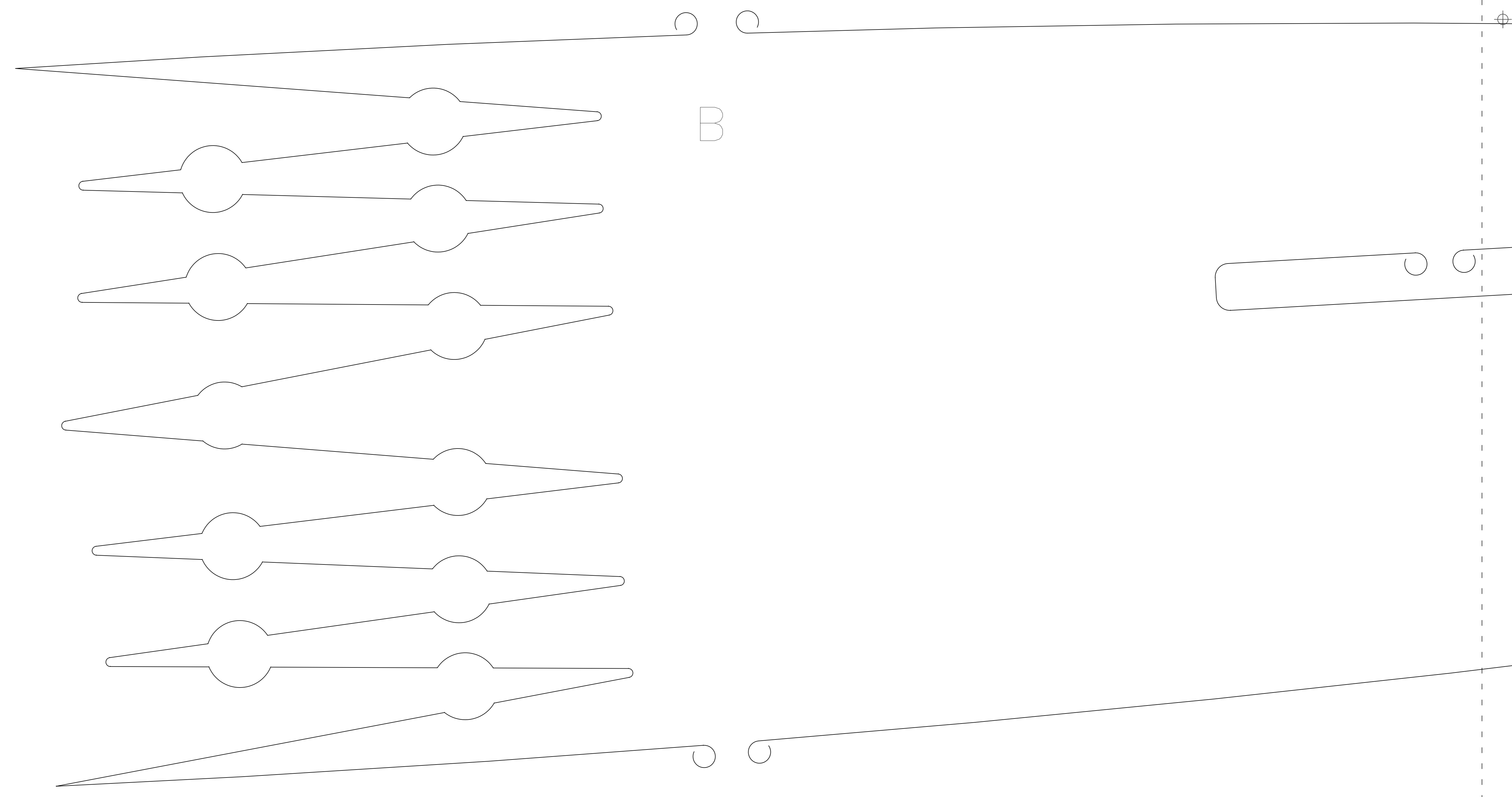

THE WESTERN SKIFF designed by Nigel Irens and Ed Burnett
 brought to you by Practical Boat Owner Magazine
 These plans are free for personal use only. Please make a donation to: www.justgiving.com/remember/201501/Ed-Burnett
 For commercial use (ie building boats for resale) contact www.nigelirens.com
 Plywood kits of the boat are available from www.jordanboats.co.uk
 Updated copies of the building templates, instructions and sail plan are available from www.pbo.co.uk



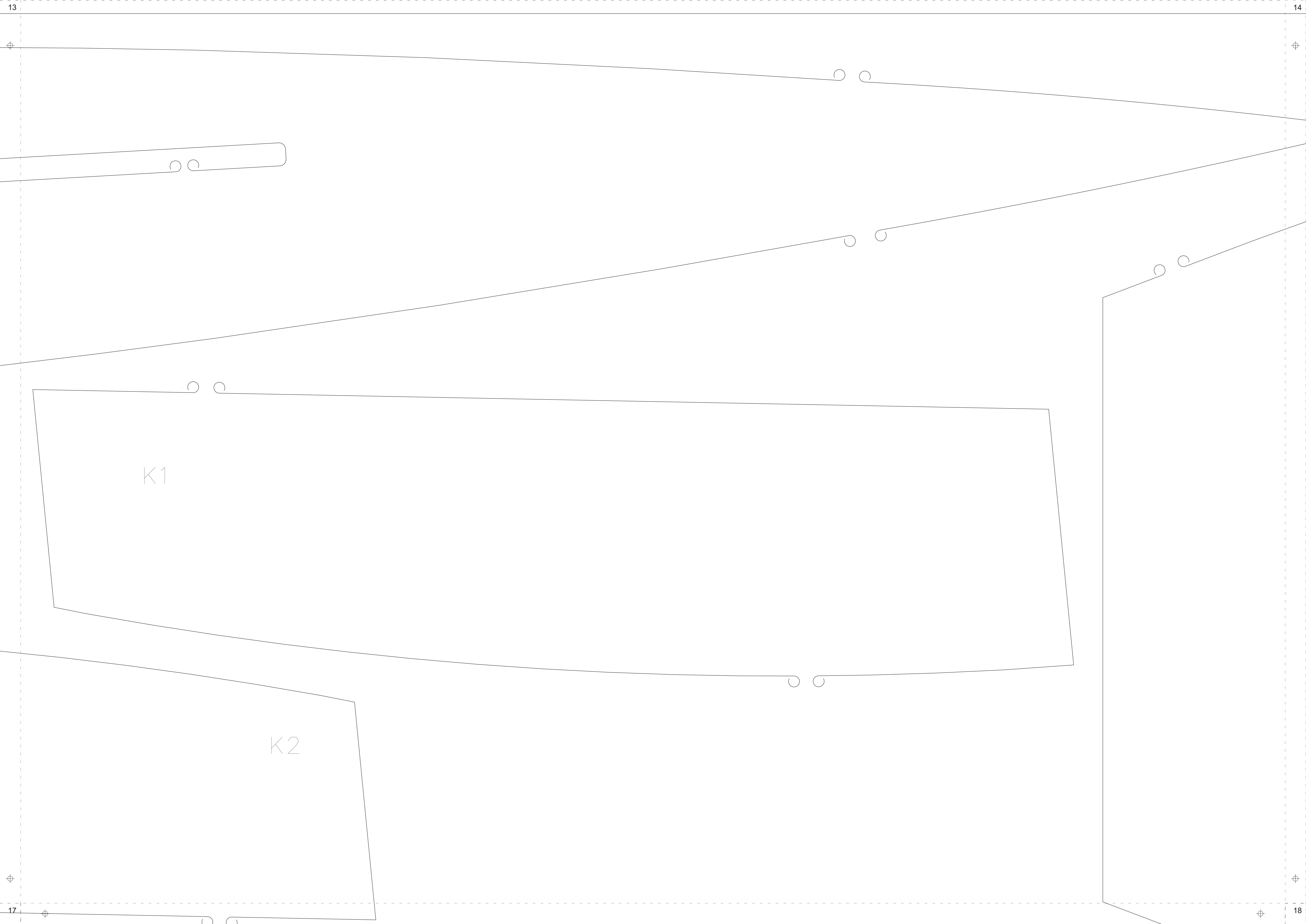

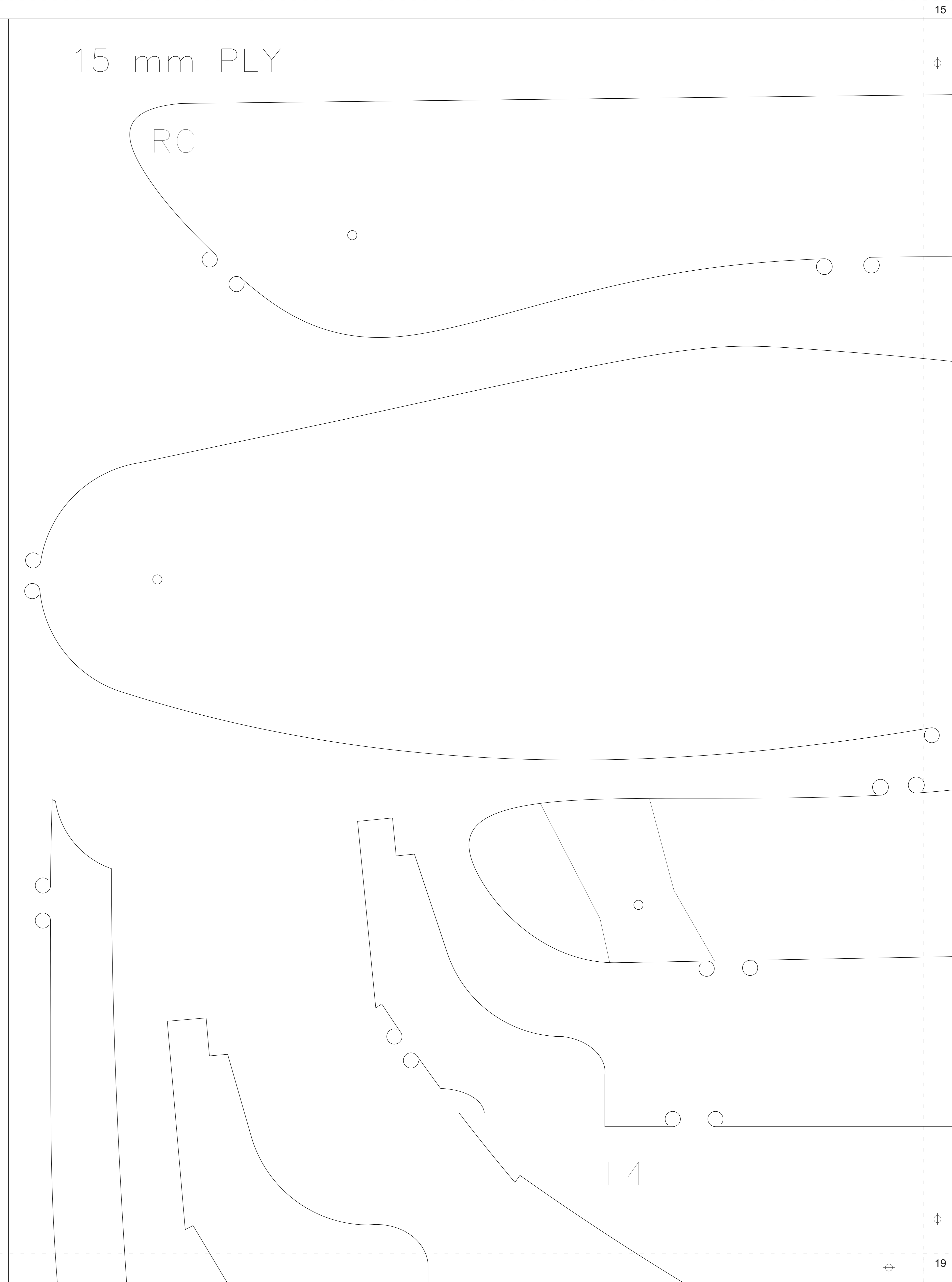
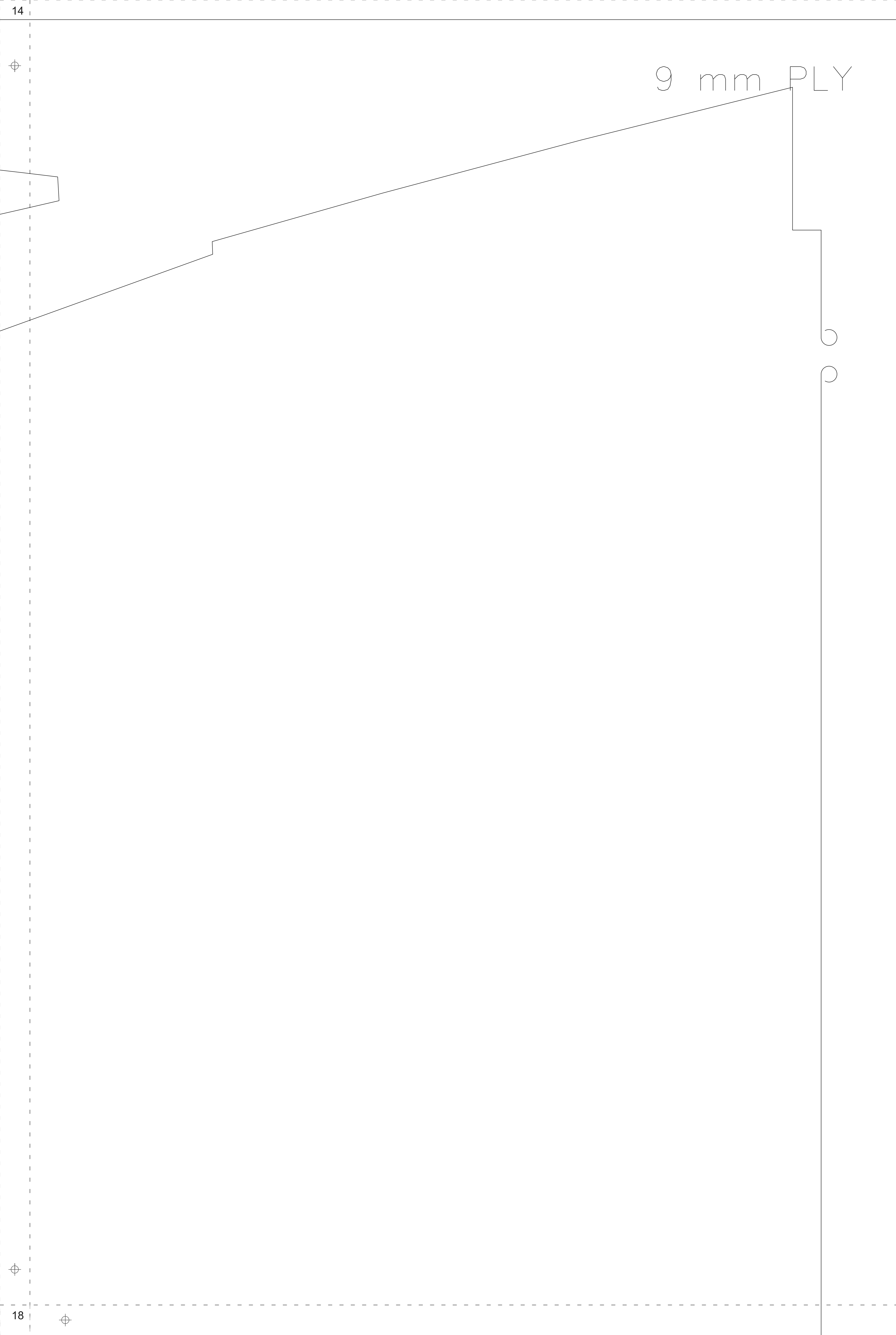



F1

RB

RC

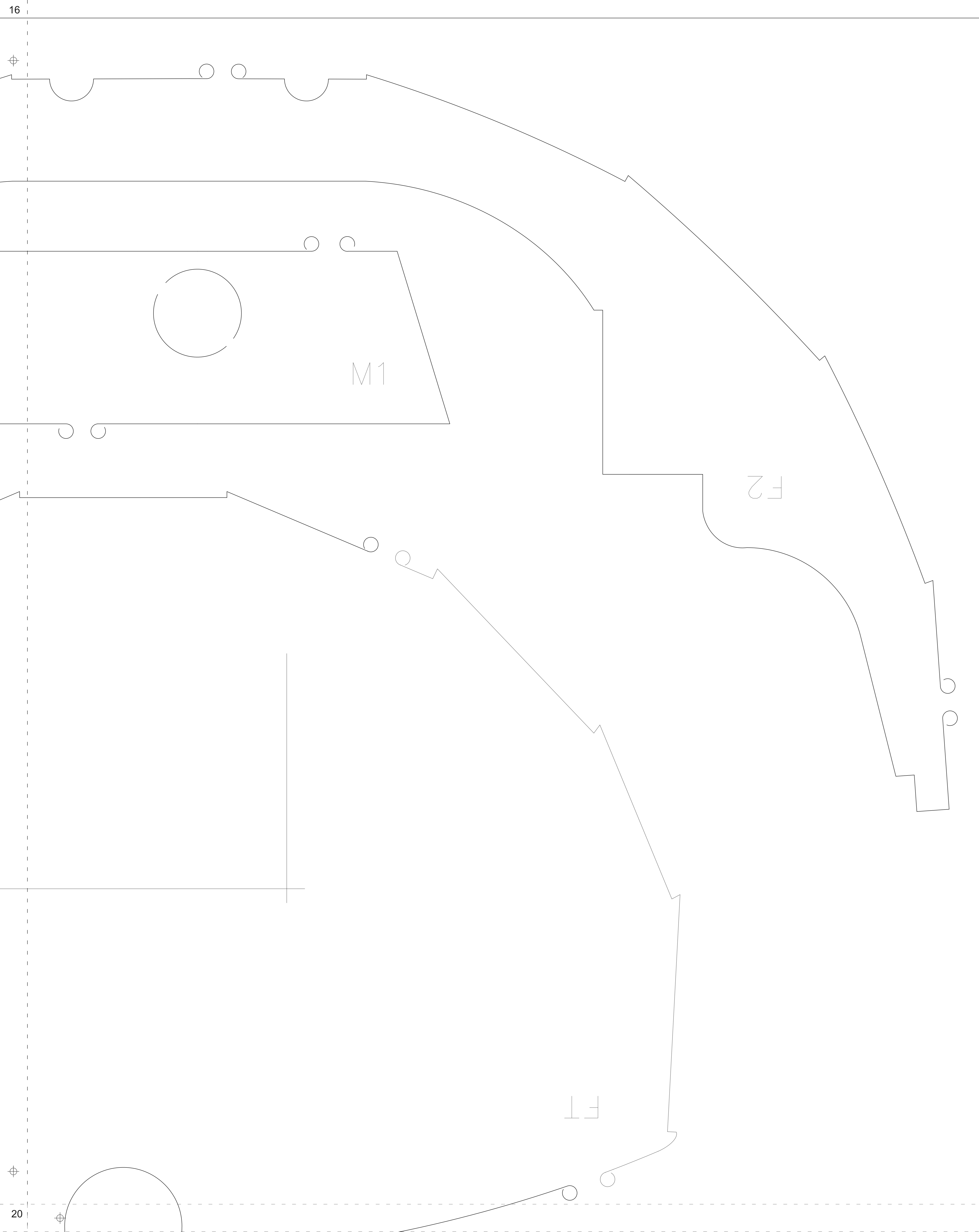

16

M1

F2

F1

20

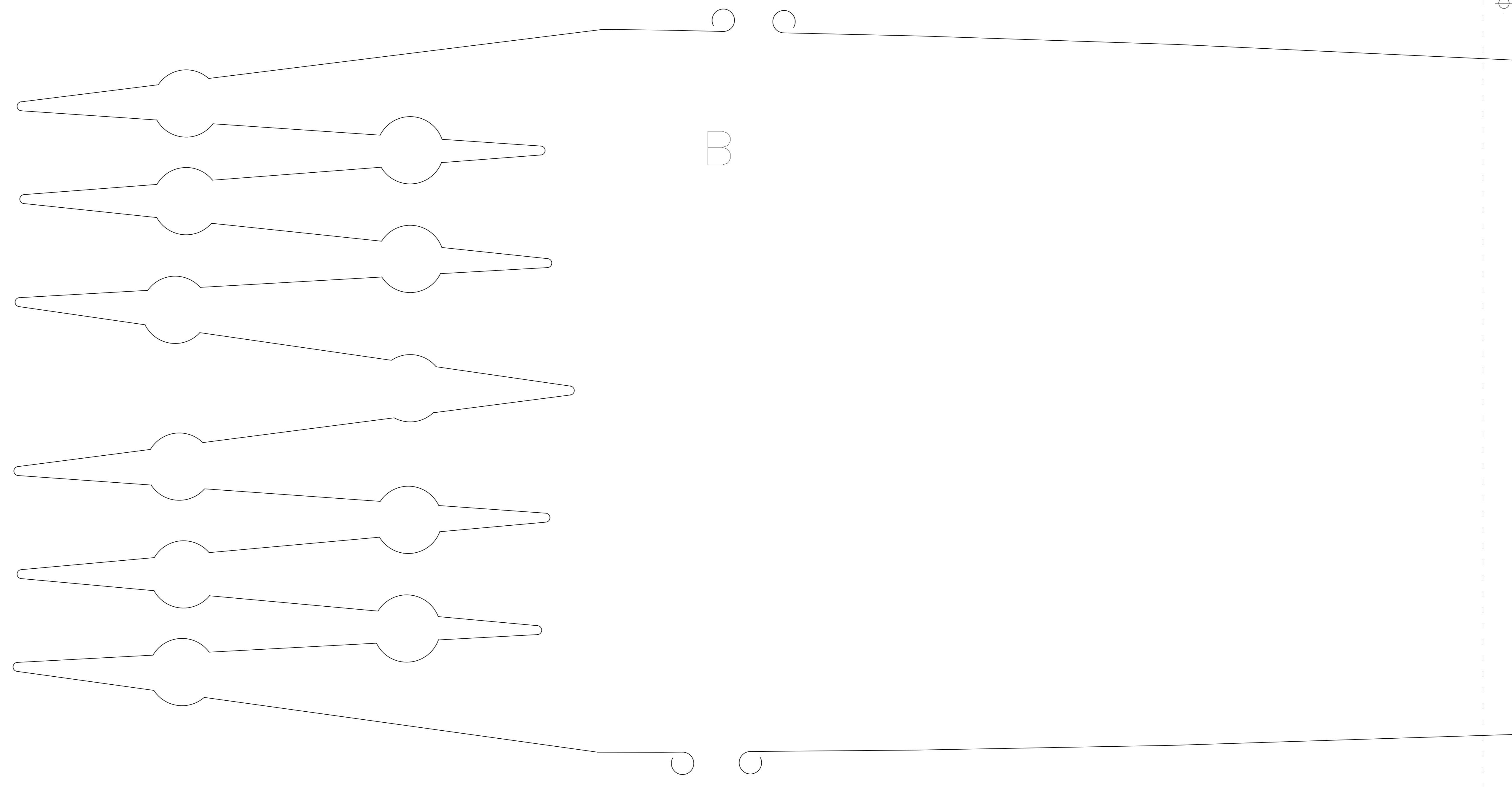

B

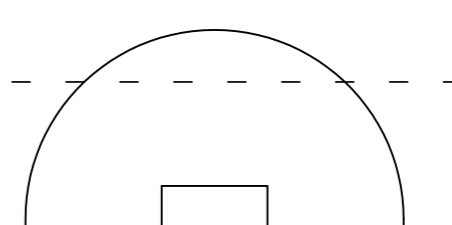
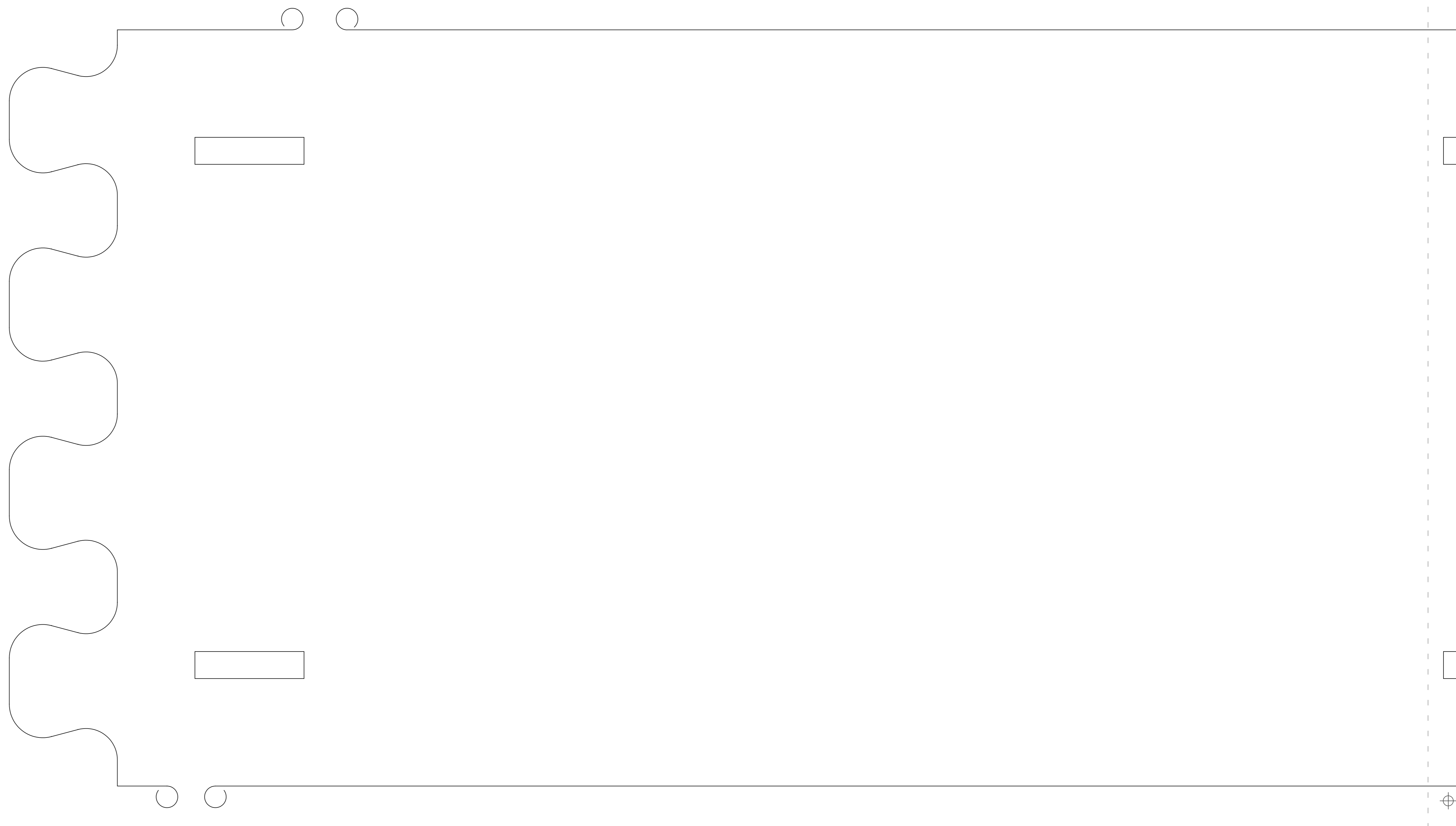

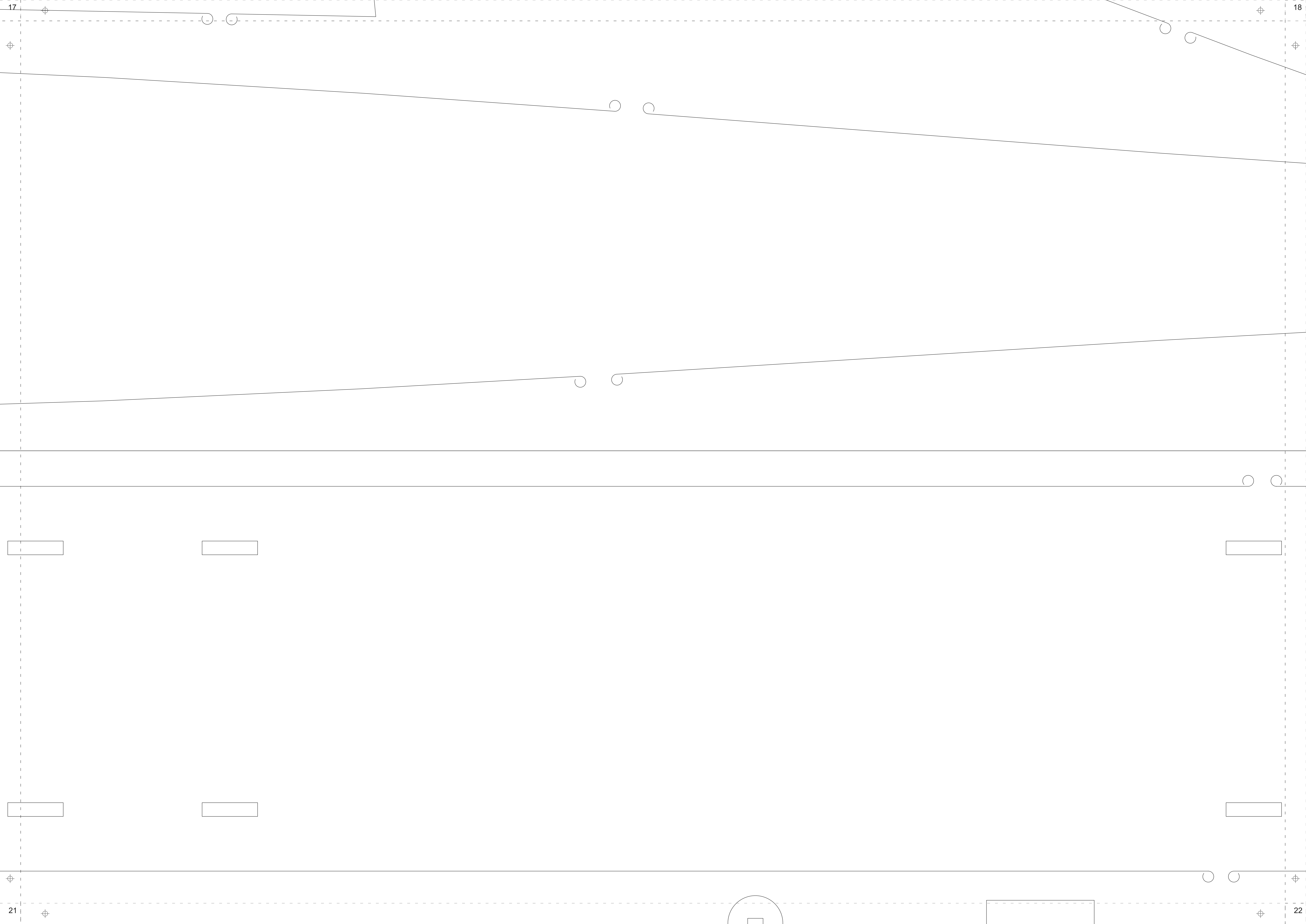

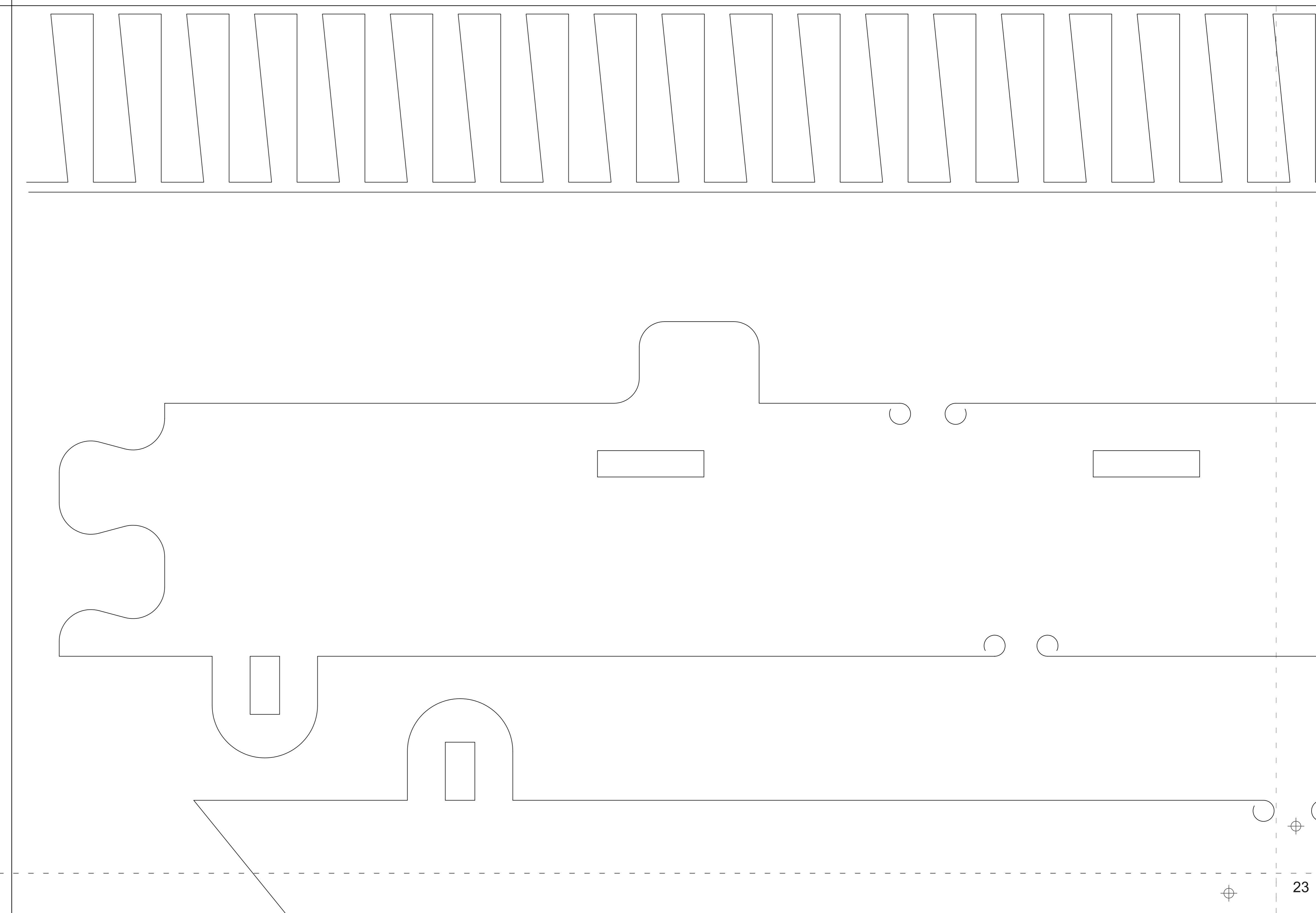
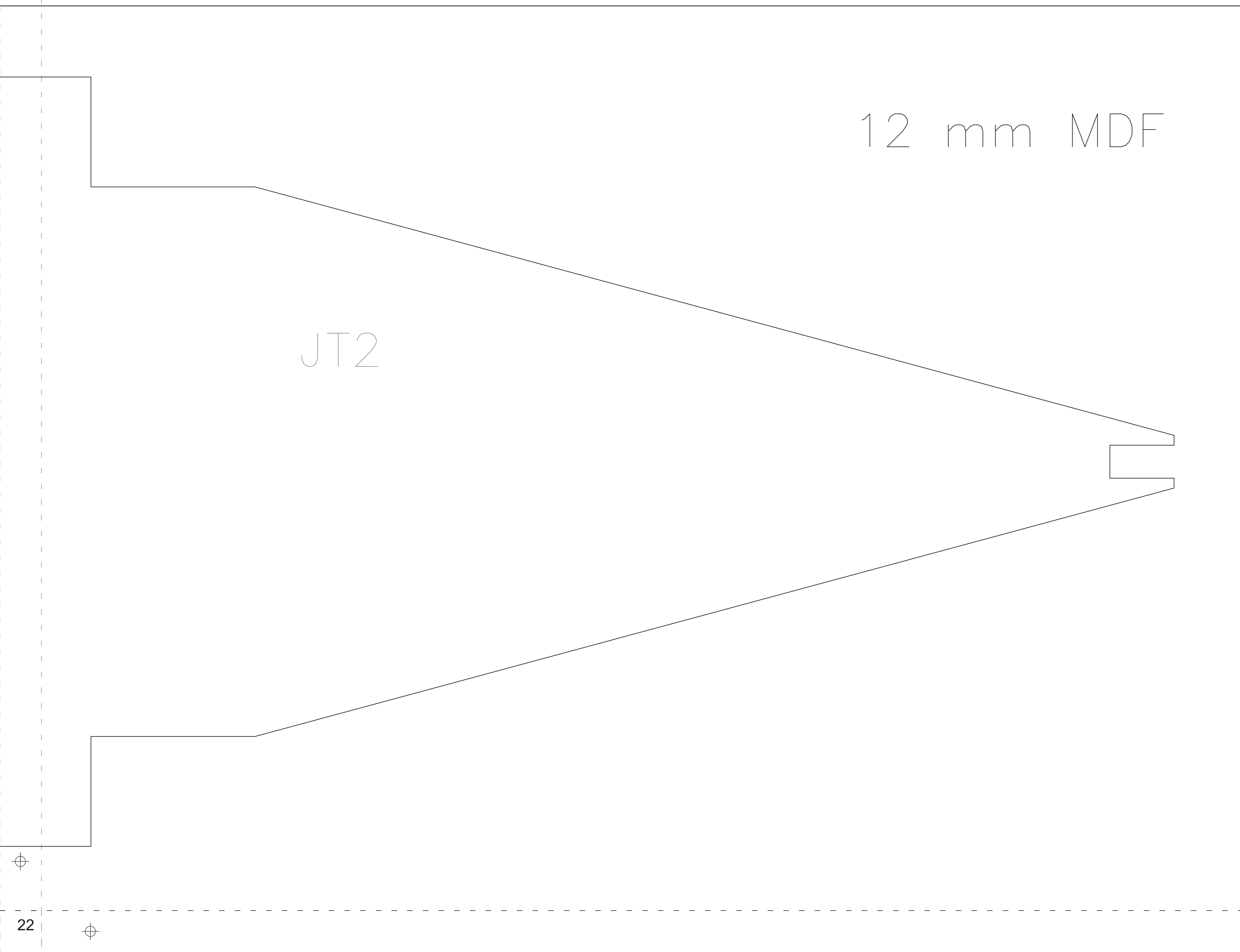
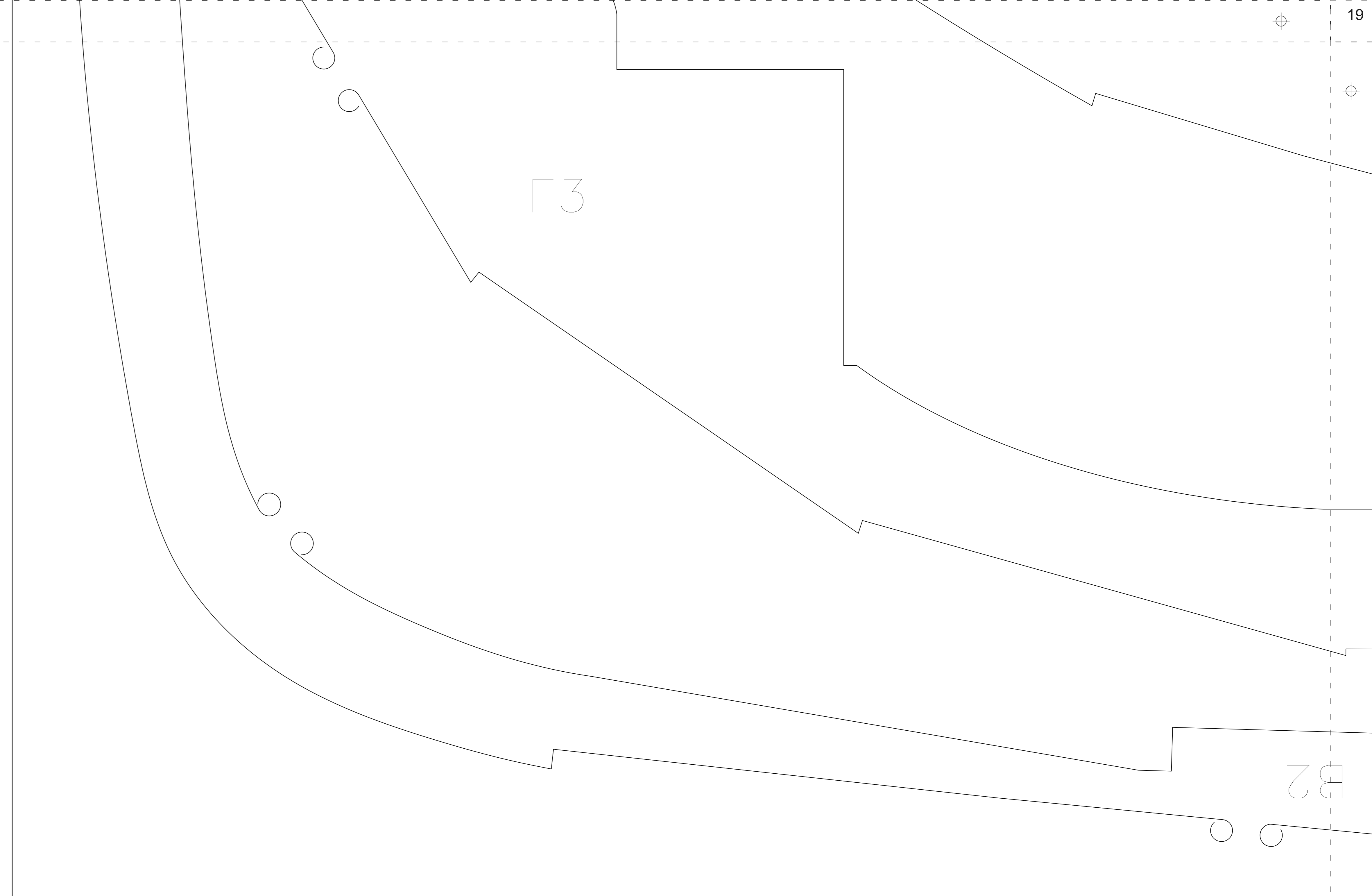
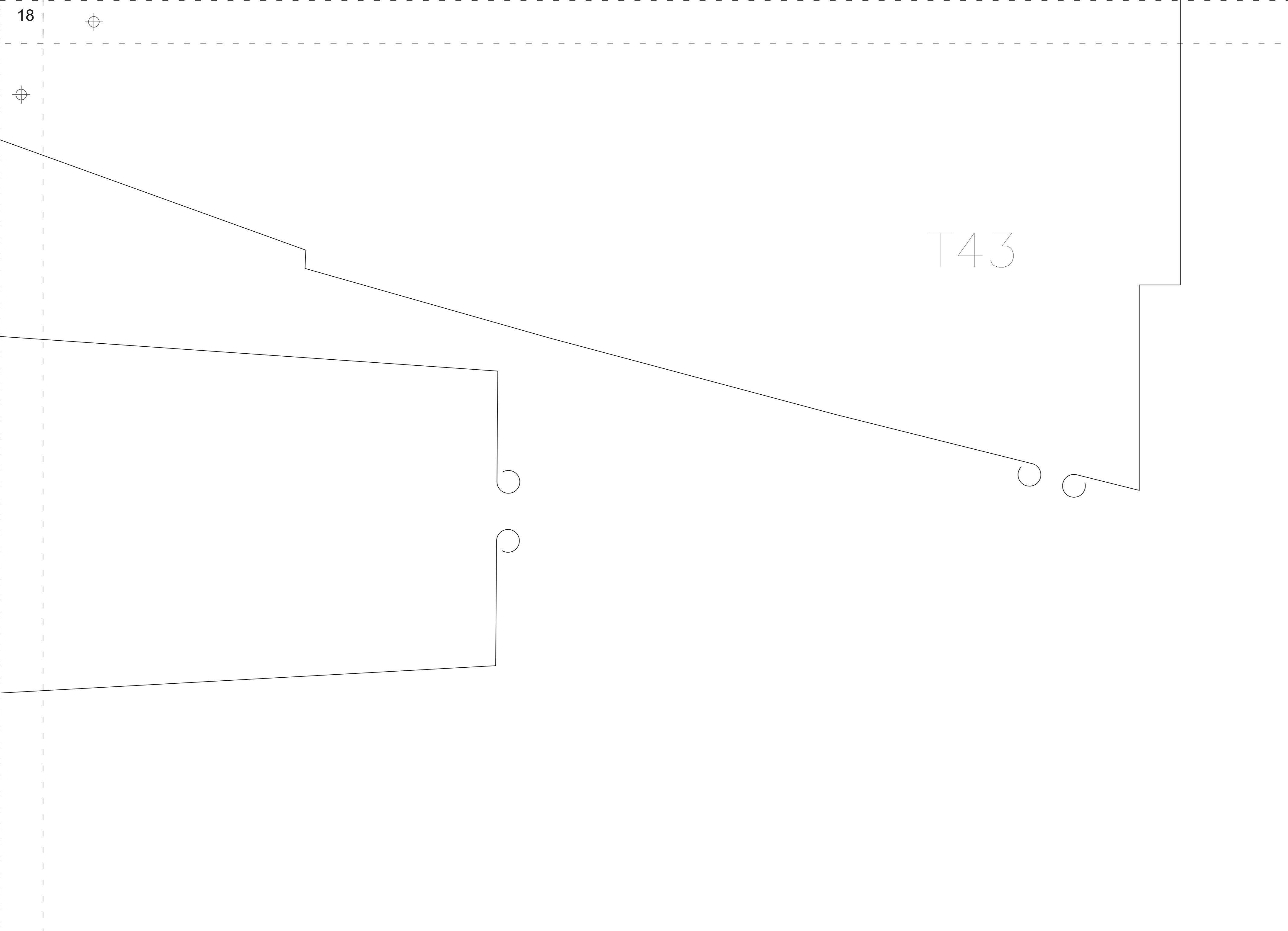

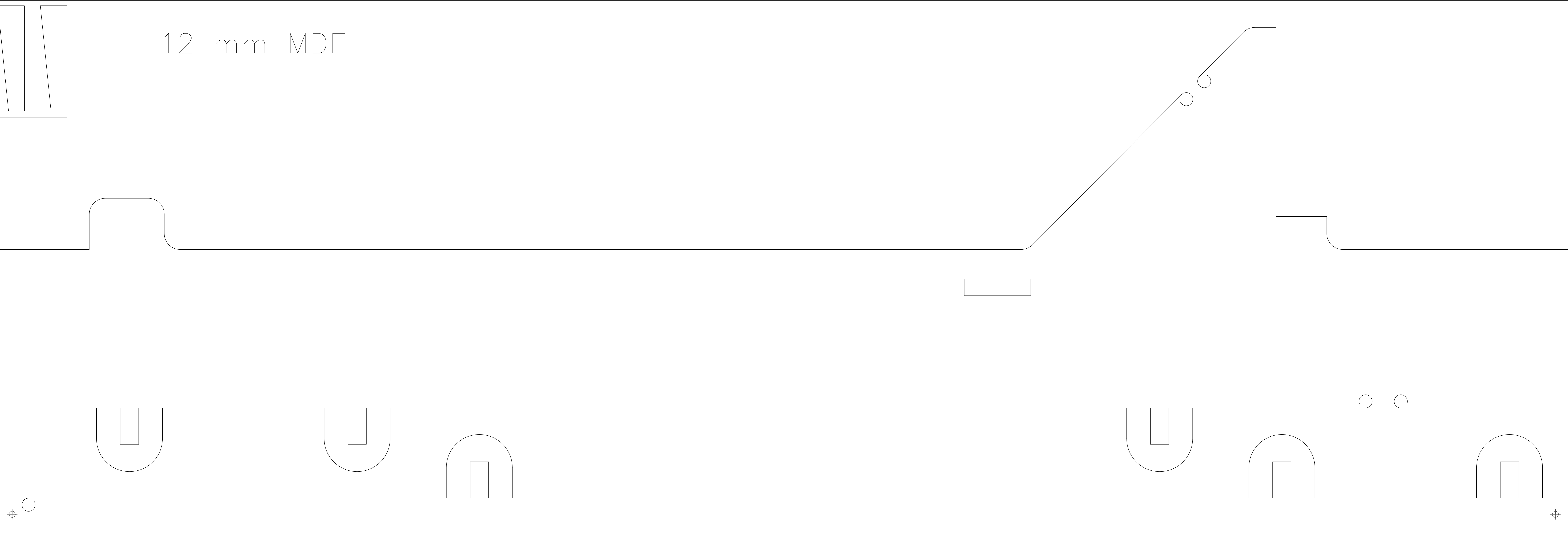
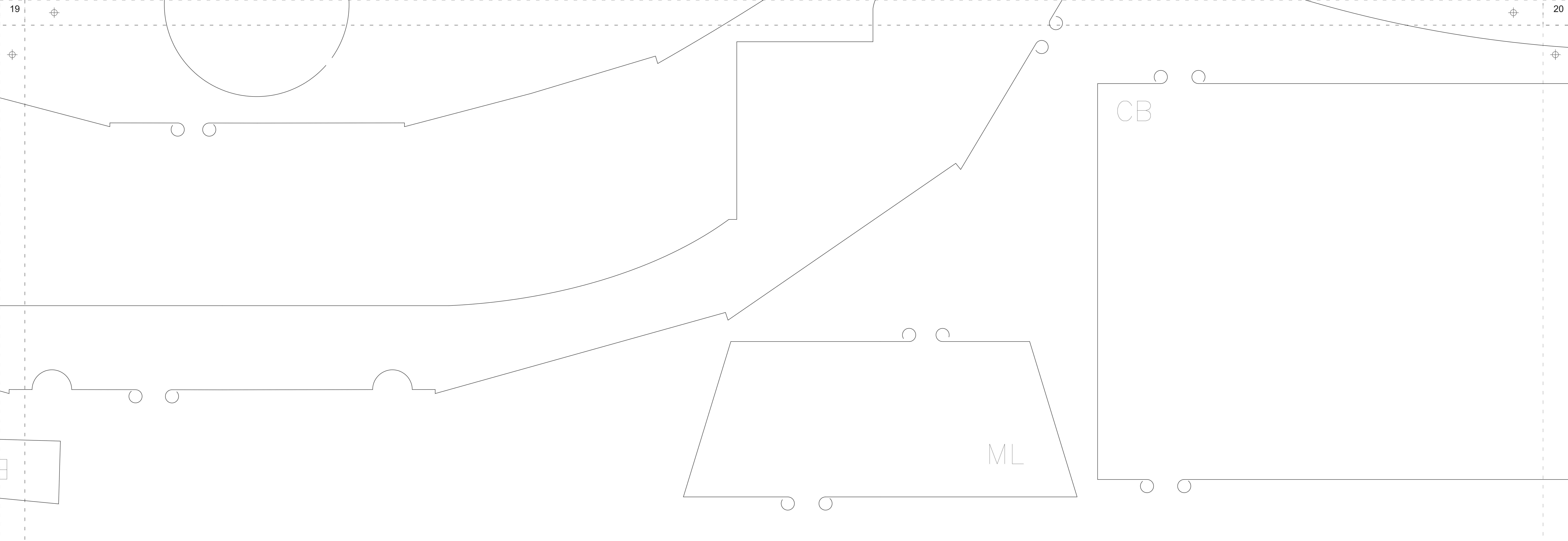

THE WESTERN SKIFF designed by Nigel Irens and Ed Burnett
brought to you by Practical Boat Owner Magazine

These plans are free for personal use only. Please make a donation to: www.justgiving.com/remember/201501/Ed-Burnett

For commercial use (ie building boats for resale) contact www.nigelirens.com

Plywood kits of the boat are available from www.jordanboats.co.uk

Updated copies of the building templates, instructions and sail plan are available from www.pbo.co.uk

JSR

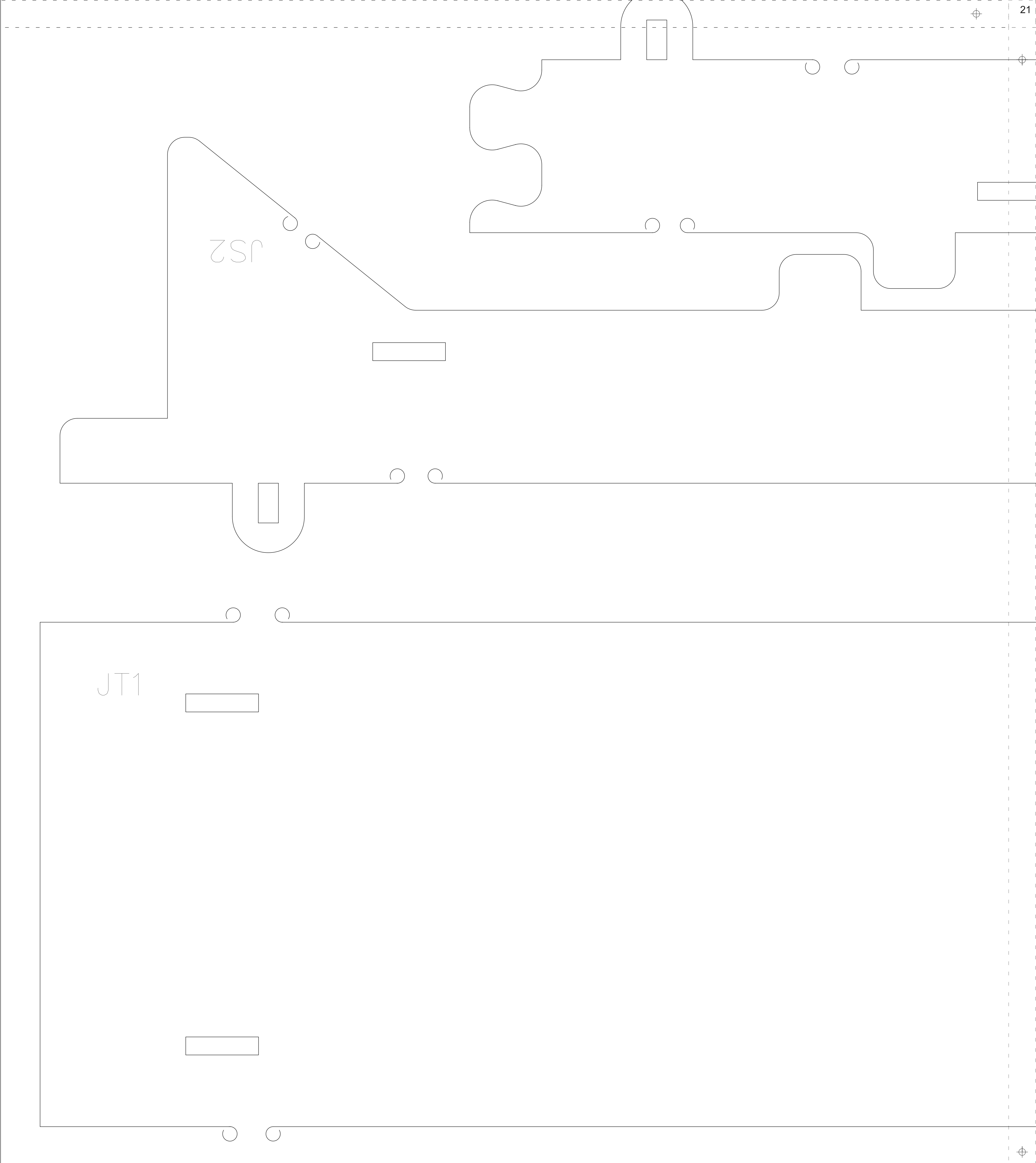

JS2

JT1

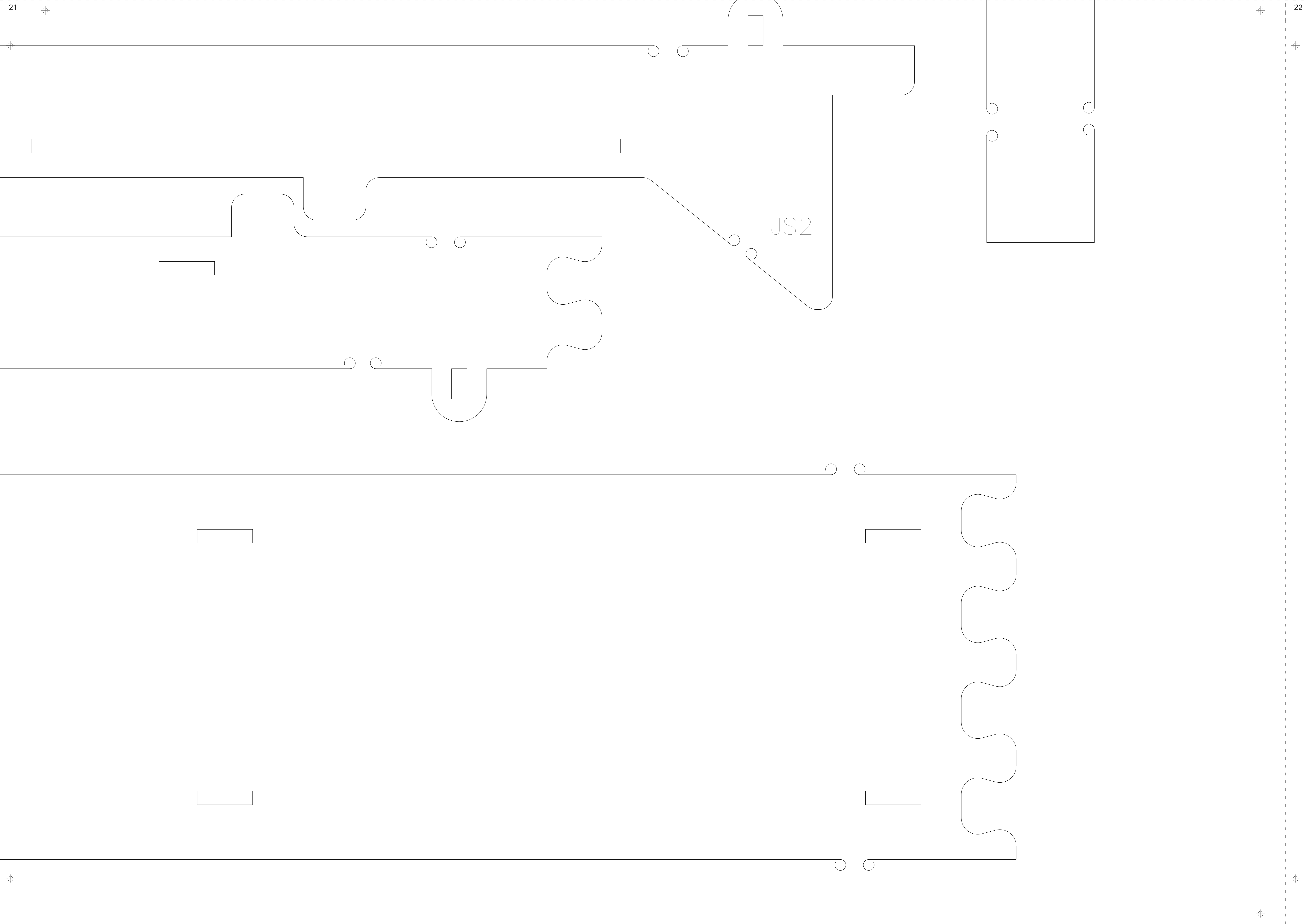

THE WESTERN SKIFF designed by Nigel Irens and Ed Burnett
brought to you by Practical Boat Owner Magazine
These plans are free for personal use only. Please make a donation to: www.justgiving.com/remember/201501/Ed-Burnett
For commercial use (ie building boats for resale) contact www.nigelirens.com
Plywood kits of the boat are available from www.jordanboats.co.uk
Updated copies of the building templates, instructions and sail plan are available from www.pbo.co.uk

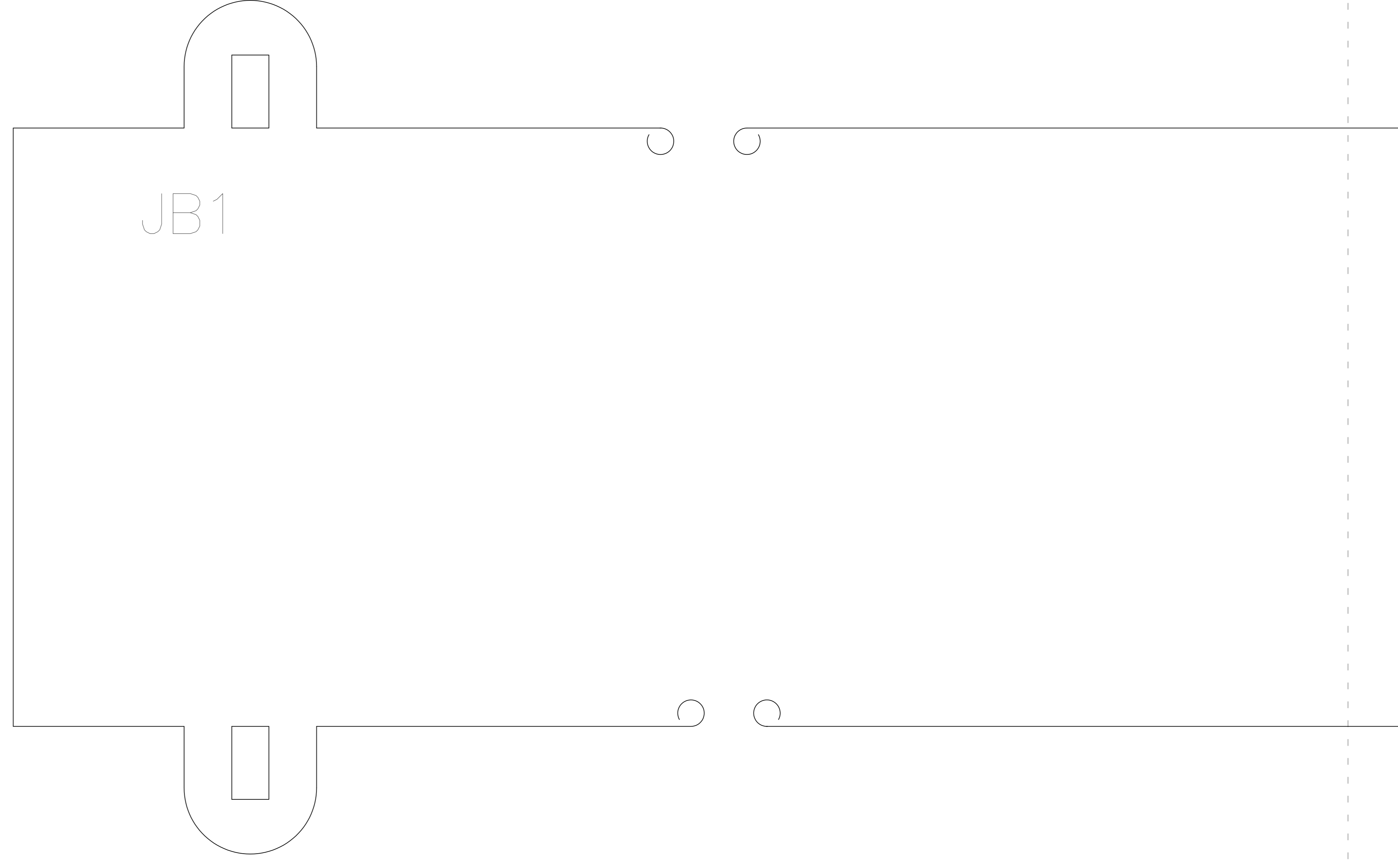

JS1

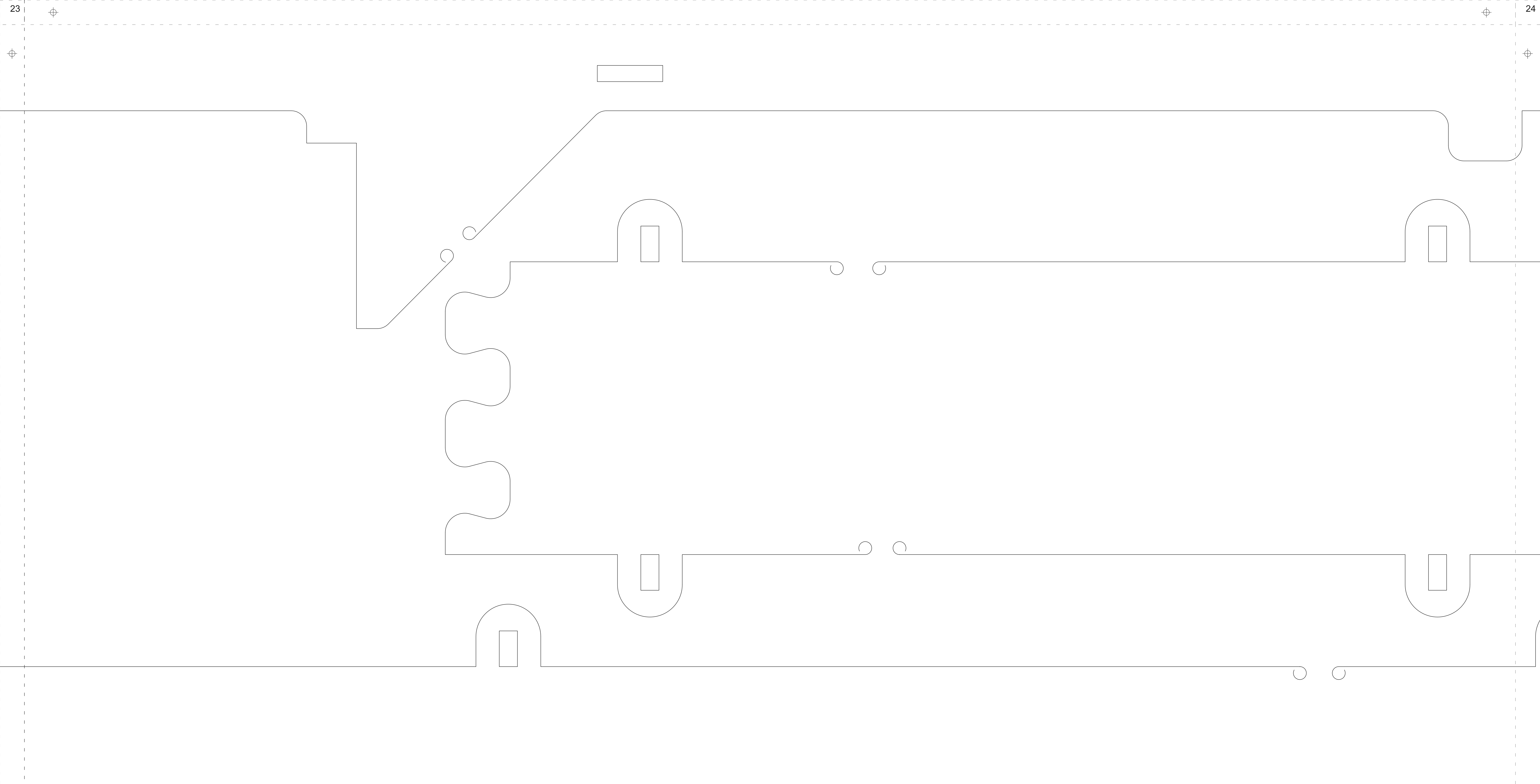

THE WESTERN SKIFF designed by Nigel Irens and Ed Burnett
brought to you by Practical Boat Owner Magazine
These plans are free for personal use only. Please make a donation to: www.justgiving.com/remember/201501/Ed-Burnett
For commercial use (ie building boats for resale) contact www.nigelirens.com
Plywood kits of the boat are available from www.jordanboats.co.uk
Updated copies of the building templates, instructions and sail plan are available from www.pbo.co.uk

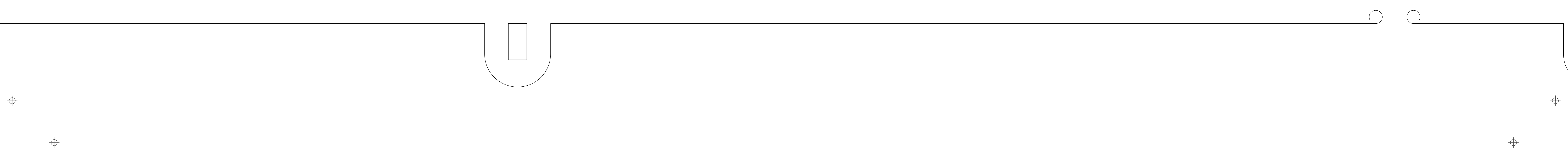

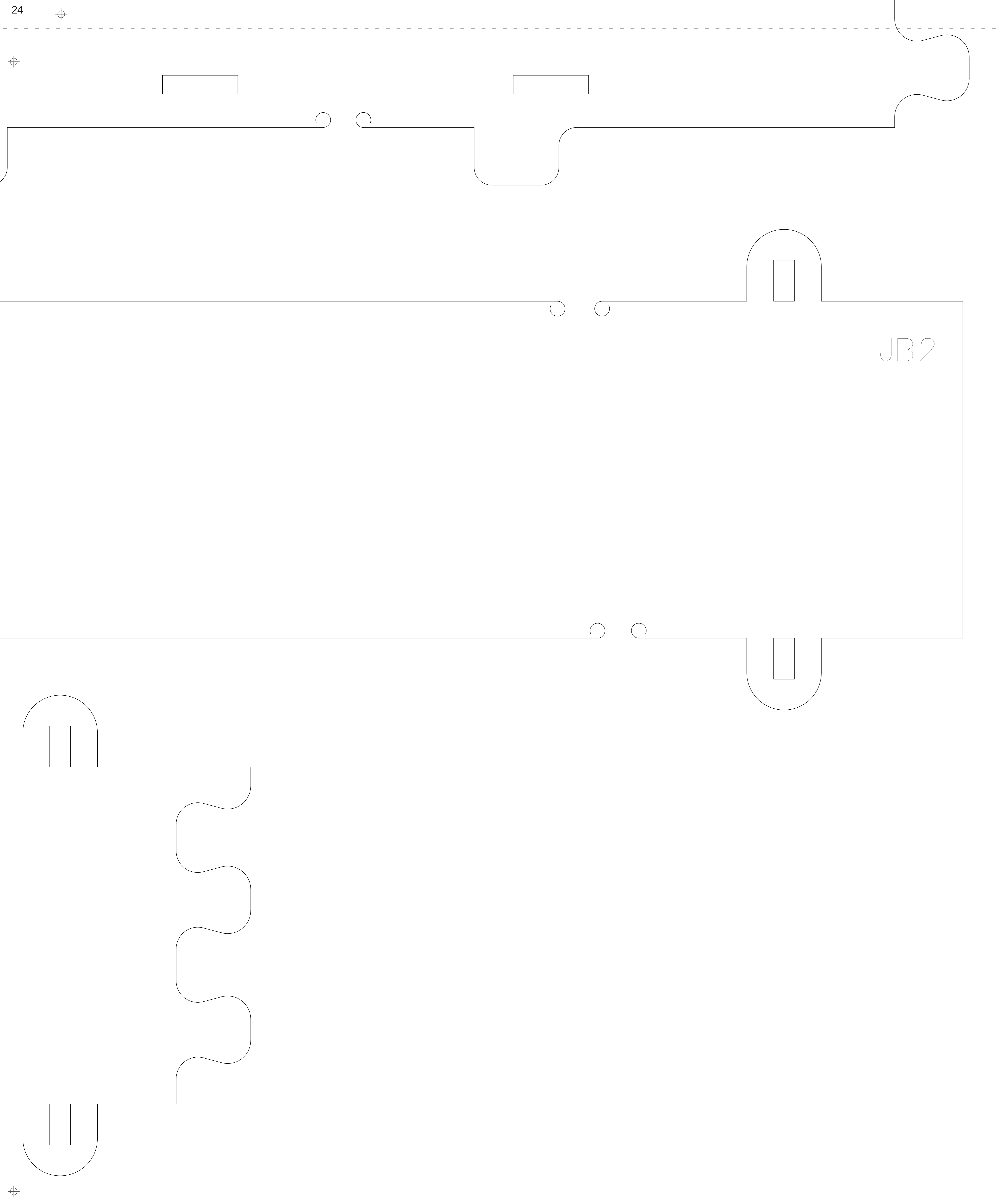

12 mm PLY

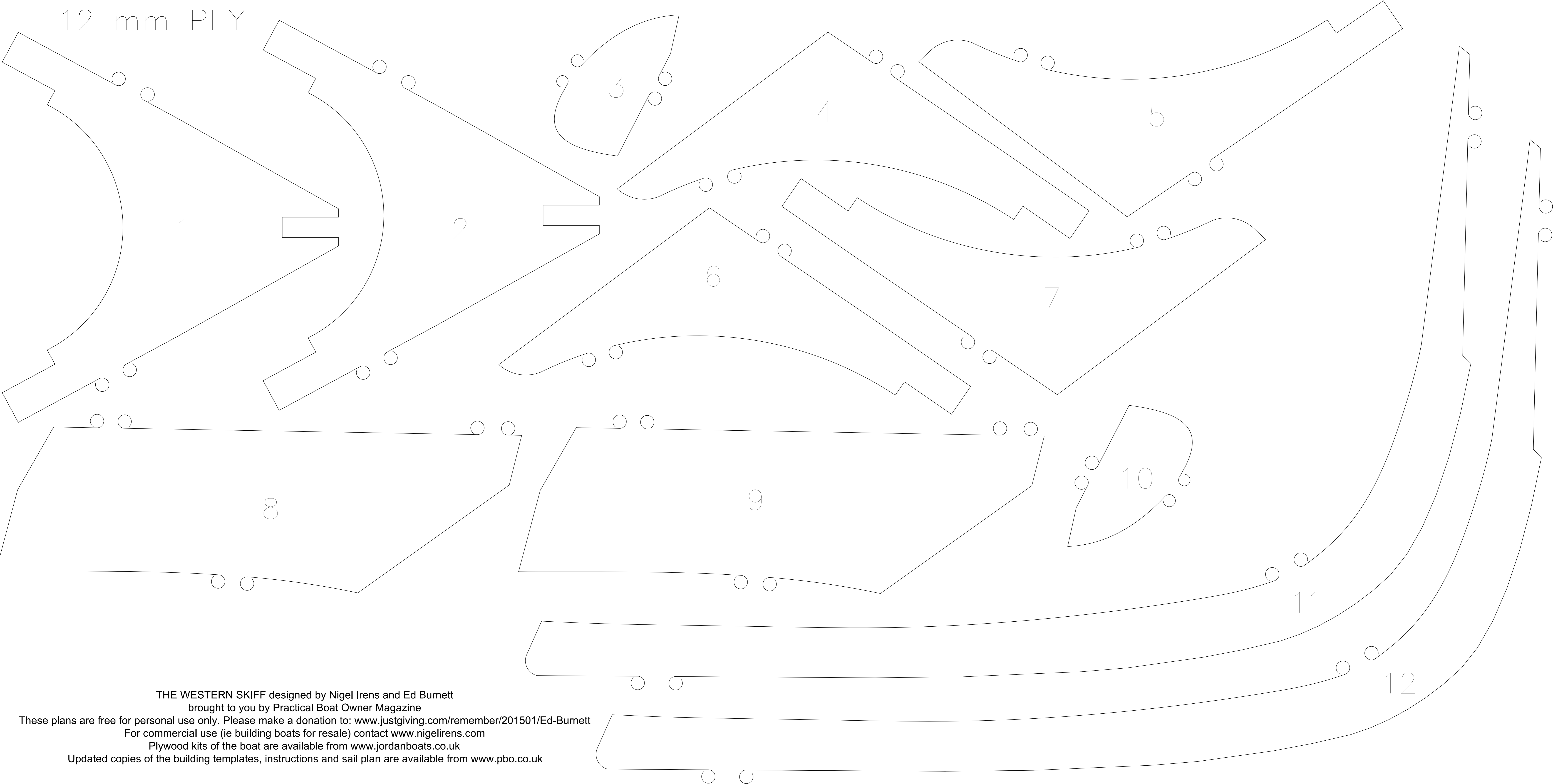

THE WESTERN SKIFF designed by Nigel Irens and Ed Burnett
 brought to you by Practical Boat Owner Magazine
 These plans are free for personal use only. Please make a donation to: www.justgiving.com/remember/201501/Ed-Burnett
 For commercial use (ie building boats for resale) contact www.nigelirens.com
 Plywood kits of the boat are available from www.jordanboats.co.uk
 Updated copies of the building templates, instructions and sail plan are available from www.pbo.co.uk

TIMBER ITEMS
WE RECOMMEND 1" DOUGLAS FIR



T6

THE WESTERN SKIFF designed by Nigel Irens and Ed Burnett
brought to you by Practical Boat Owner Magazine
These plans are free for personal use only. Please make a donation to: www.justgiving.com/remember/201501/Ed-Burnett
For commercial use (ie building boats for resale) contact www.nigelirens.com
Plywood kits of the boat are available from www.jordanboats.co.uk
Updated copies of the building templates, instructions and sail plan are available from www.pbo.co.uk

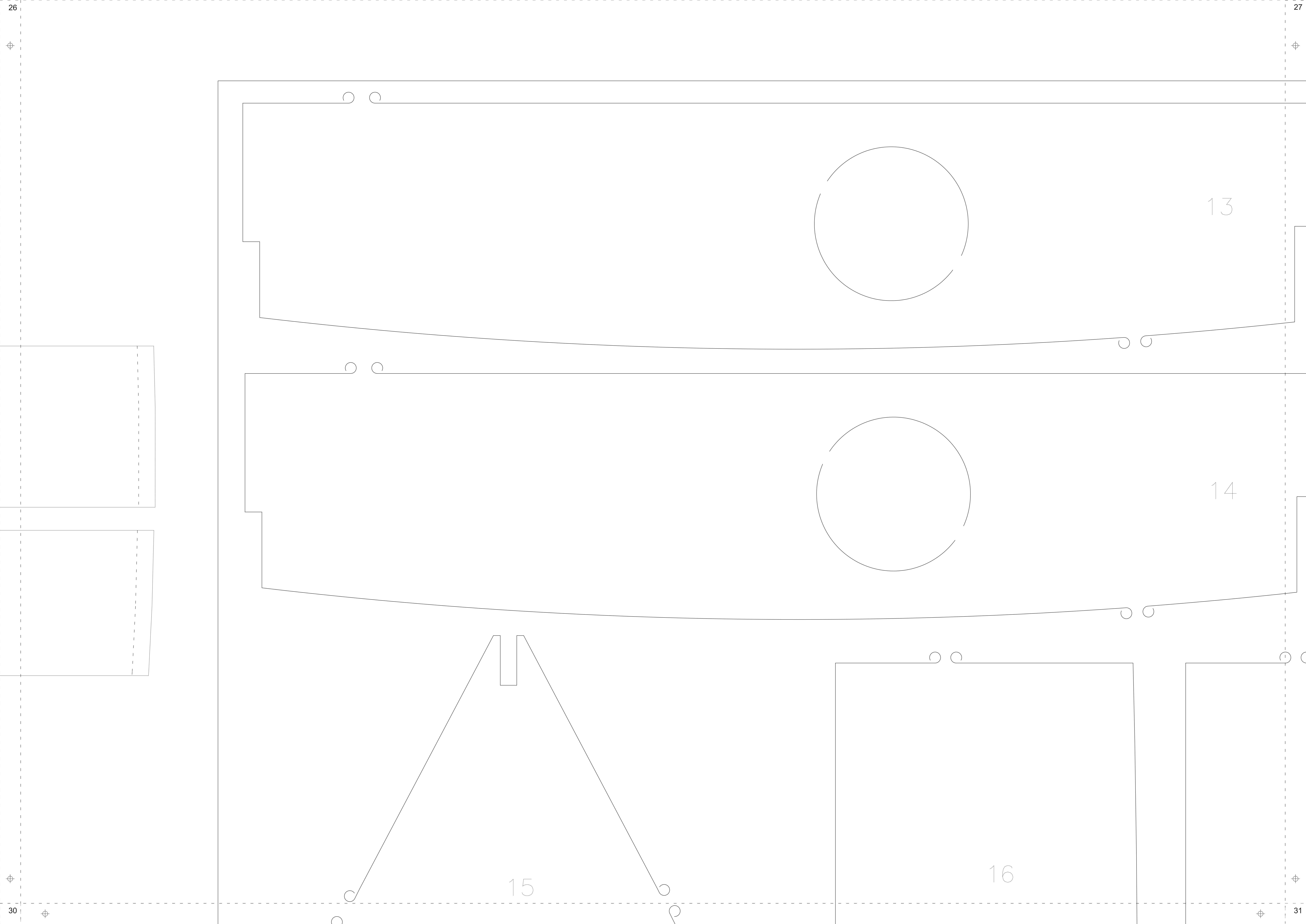

6 mm PLY

THE WESTERN SKIFF designed by Nigel Irens and Ed Burnett
brought to you by Practical Boat Owner Magazine
These plans are free for personal use only. Please make a donation to: www.justgiving.com/remember/201501/Ed-Burnett
For commercial use (ie building boats for resale) contact www.nigelirens.com
Plywood kits of the boat are available from www.jordanboats.co.uk
Updated copies of the building templates, instructions and sail plan are available from www.pbo.co.uk

THE WESTERN SKIFF designed by Nigel Irens and Ed Burnett
brought to you by Practical Boat Owner Magazine
These plans are free for personal use only. Please make a donation to: www.justgiving.com/remember/201501/Ed-Burnett
For commercial use (ie building boats for resale) contact www.nigelirens.com
Plywood kits of the boat are available from www.jordanboats.co.uk
Updated copies of the building templates, instructions and sail plan are available from www.pbo.co.uk

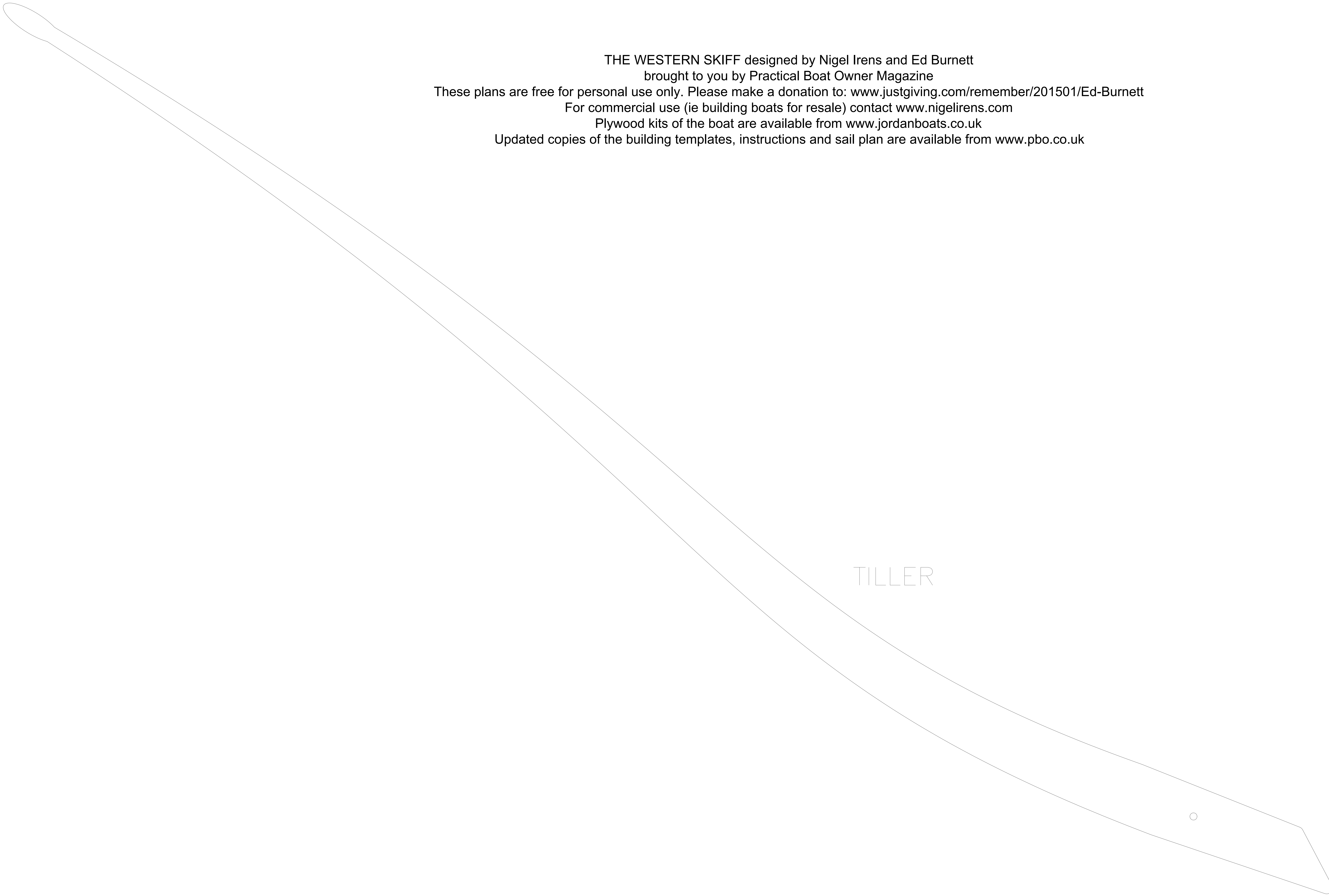

TILLER



THE WESTERN SKIFF designed by Nigel Irens and Ed Burnett
 brought to you by Practical Boat Owner Magazine
 These plans are free for personal use only. Please make a donation to: www.justgiving.com/remember/201501/Ed-Burnett
 For commercial use (ie building boats for resale) contact www.nigelirens.com
 Plywood kits of the boat are available from www.jordanboats.co.uk
 Updated copies of the building templates, instructions and sail plan are available from www.pbo.co.uk

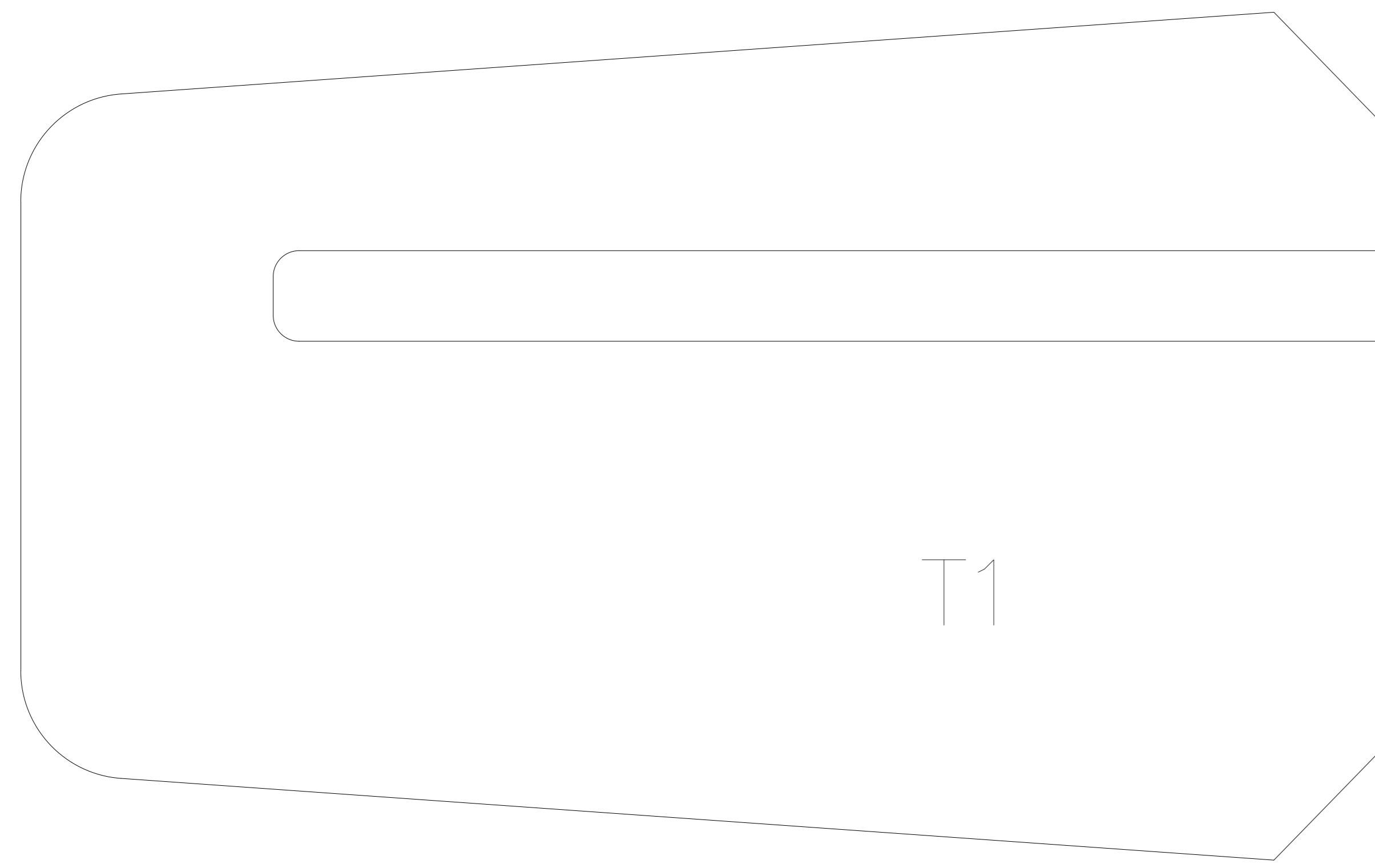

T1

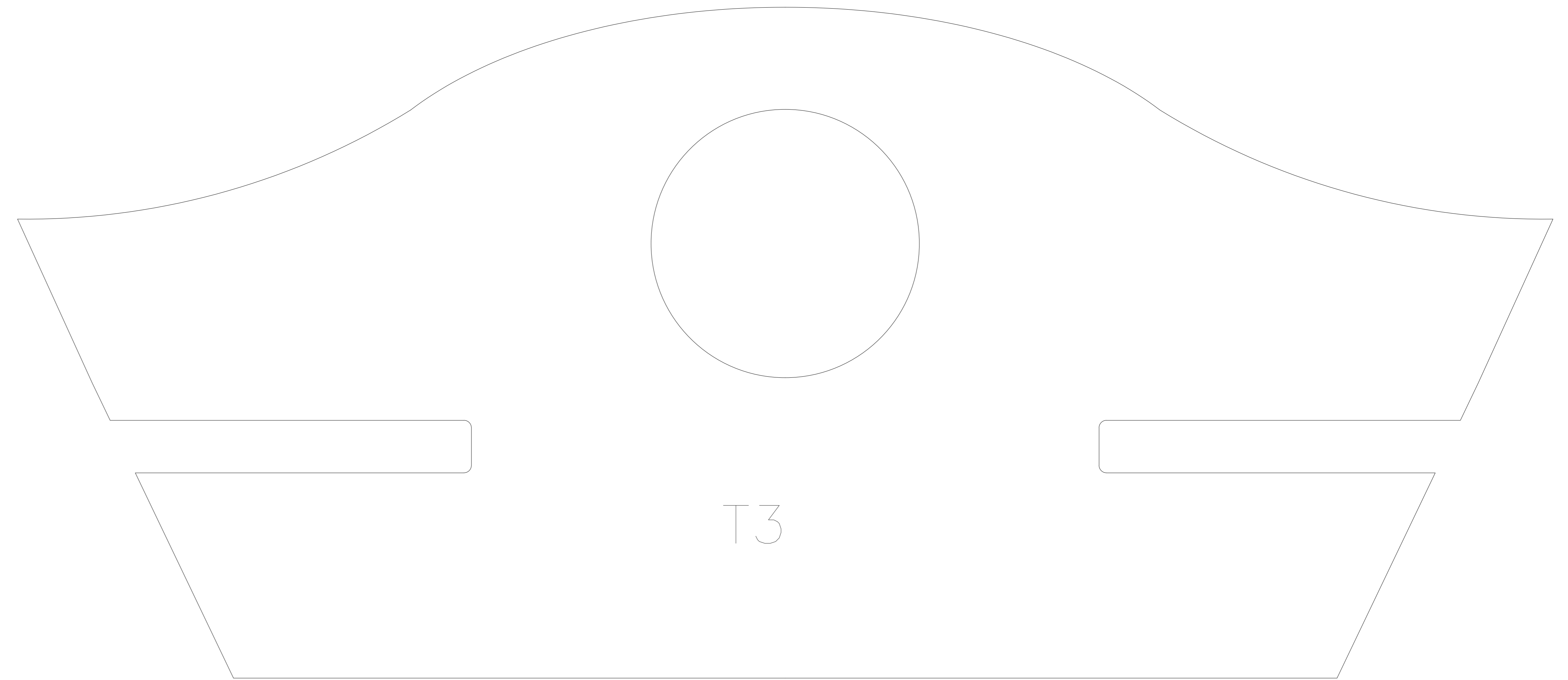

T3

TIMBER ITEMS
 WE RECOMMEND 1" DOUGLAS FIR



T5

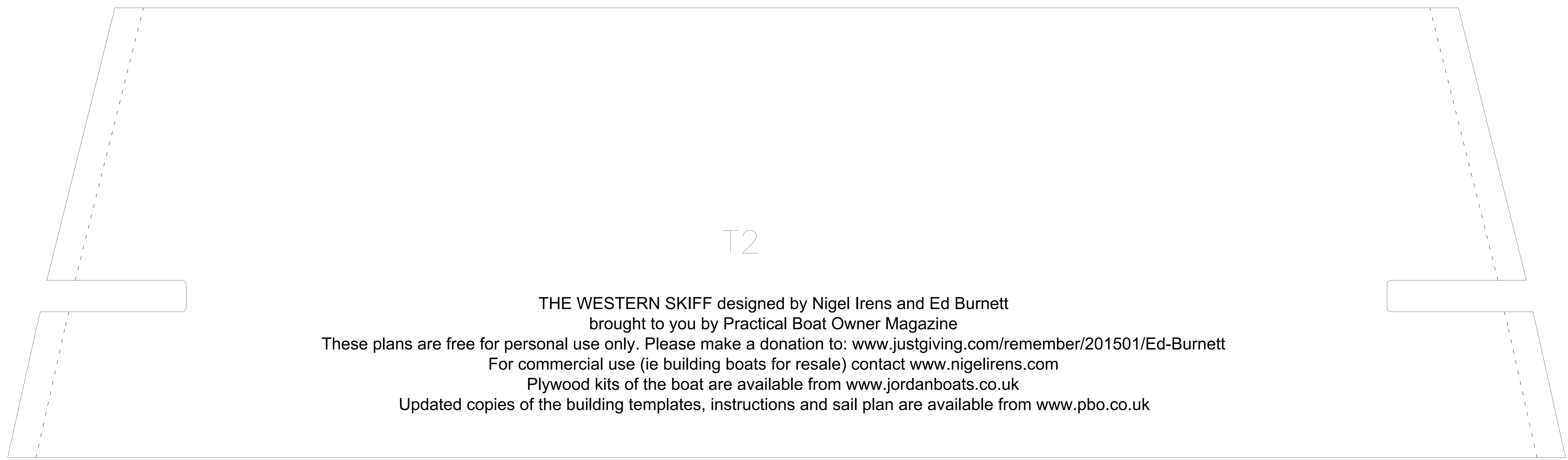

T2

THE WESTERN SKIFF designed by Nigel Irens and Ed Burnett
 brought to you by Practical Boat Owner Magazine
 These plans are free for personal use only. Please make a donation to: www.justgiving.com/remember/201501/Ed-Burnett
 For commercial use (ie building boats for resale) contact www.nigelirens.com
 Plywood kits of the boat are available from www.jordanboats.co.uk
 Updated copies of the building templates, instructions and sail plan are available from www.pbo.co.uk

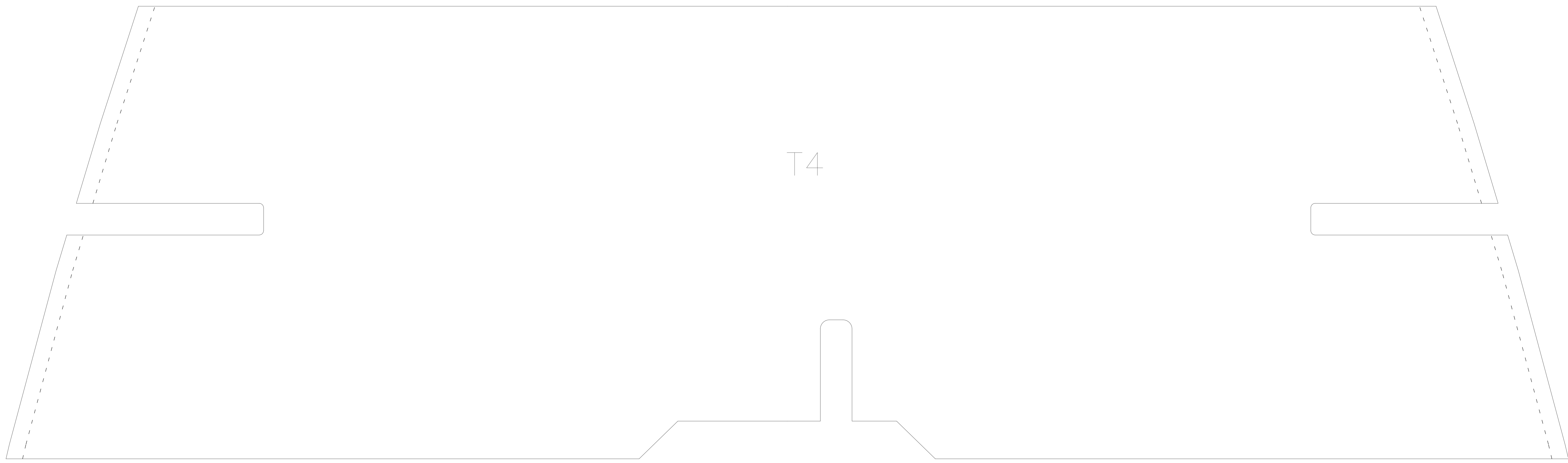

T4

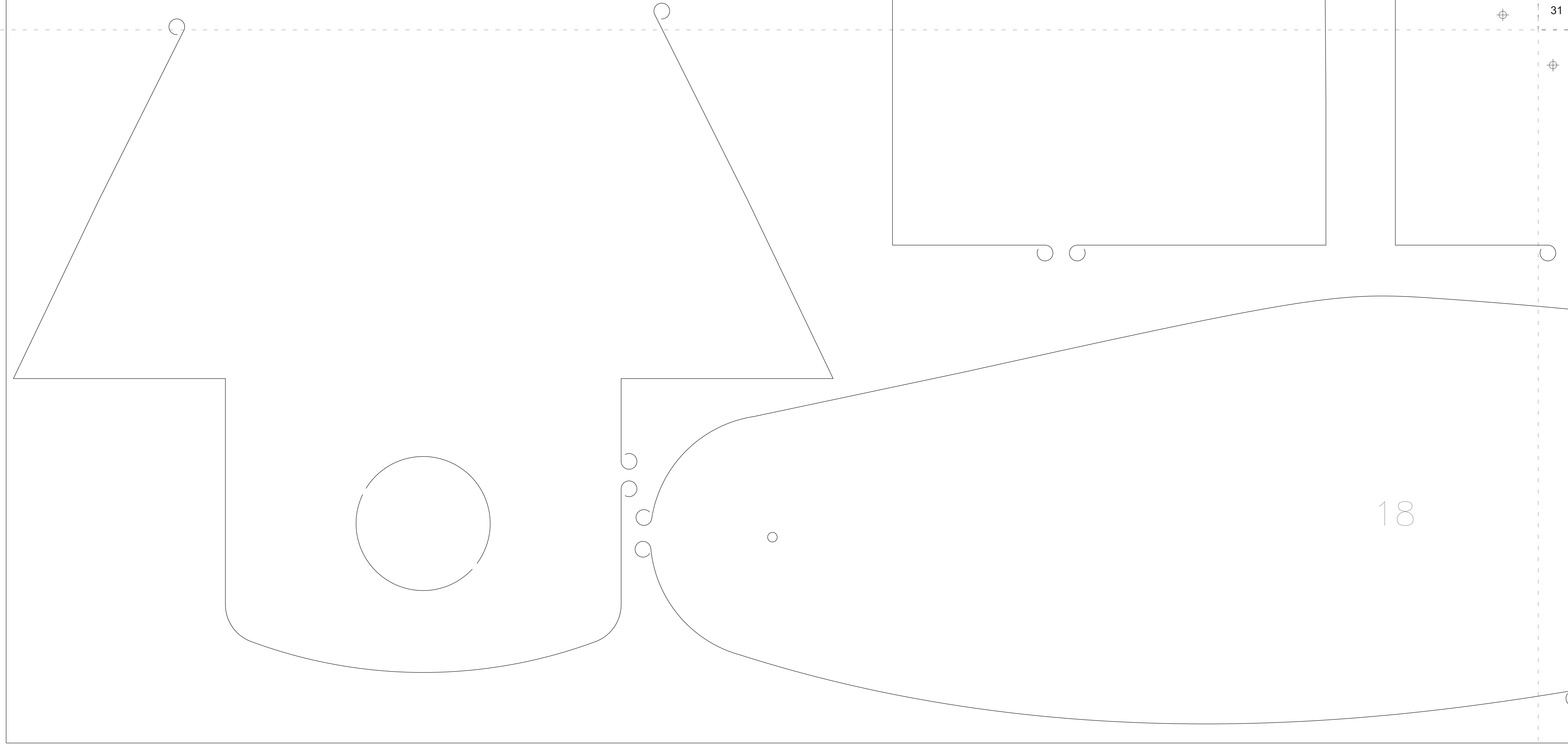

THE WESTERN SKIFF designed by Nigel Irens and Ed Burnett
brought to you by Practical Boat Owner Magazine

These plans are free for personal use only. Please make a donation to: www.justgiving.com/remember/201501/Ed-Burnett

For commercial use (ie building boats for resale) contact www.nigelirens.com

Plywood kits of the boat are available from www.jordanboats.co.uk

Updated copies of the building templates, instructions and sail plan are available from www.pbo.co.uk

